

Narzędzia niezbędne do montażu
(nie dostarczane przez producenta)

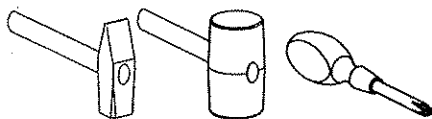

Maksymalne obciążenie półek w kg:

Grubość (mm) \ Długość (mm)	Płyta			Szkló
	16	18	22	4
0 < 400	45	47	50	Długość do 600 mm/15kg
401 < 600	40	42	45	
601 < 800	25	47	30	Długość do 900 mm/10kg
801 < 1000	15	17	20	

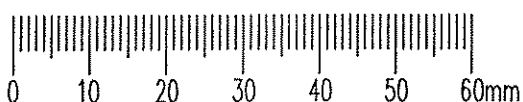

Szanowny kliencie, gdyby brakowało jakiejś części lub byłaby uszkodzona proszę to oznaczyć krzyżykiem na instrukcji montażowej i przesać instrukcję razem z reklamacją.

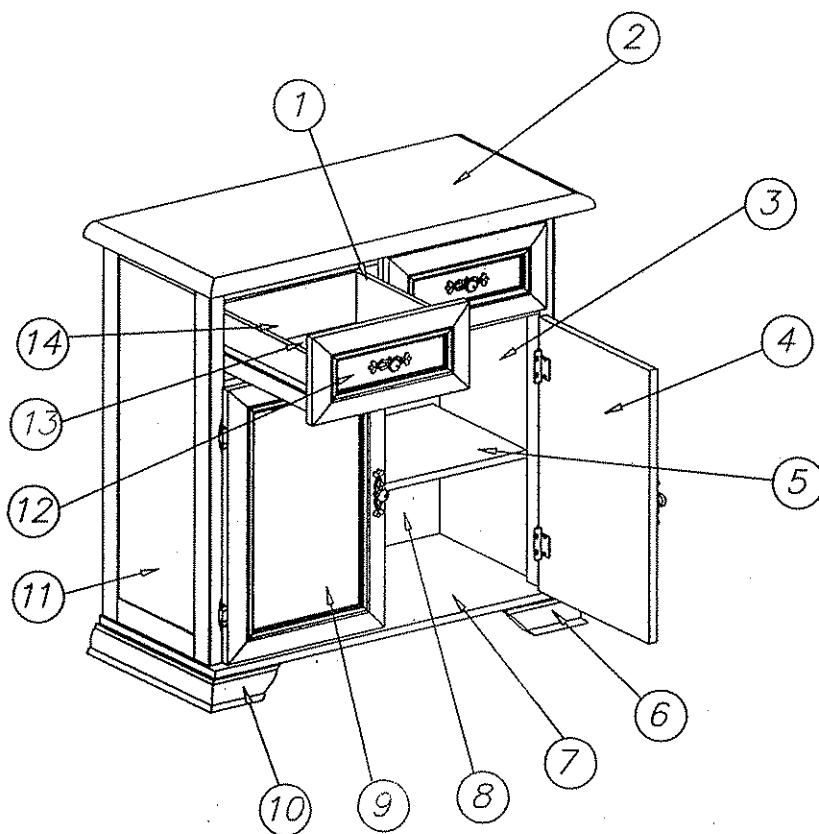
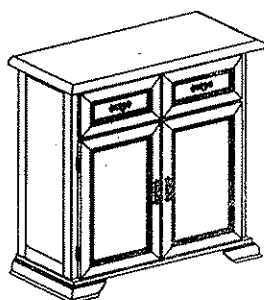

Wskazówka dotycząca pielęgnacji !

Proszę czyścić tylko suchą lub lekko wilgotną szmatką do kurzu.
Nie używać żadnych środków szorstkich!

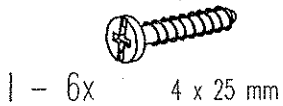
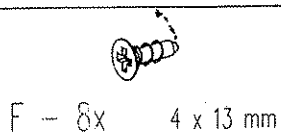
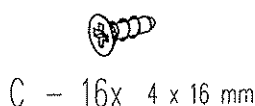
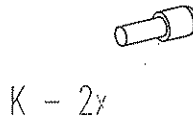
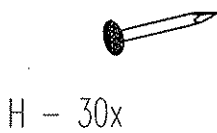
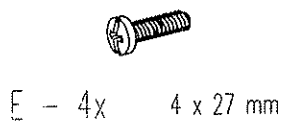
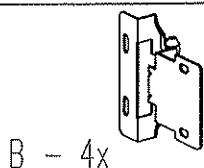
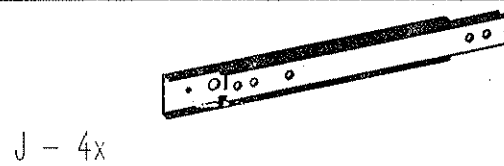
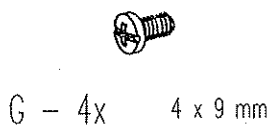
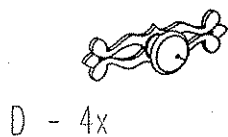
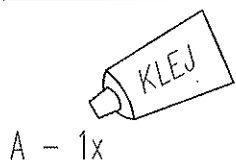

1

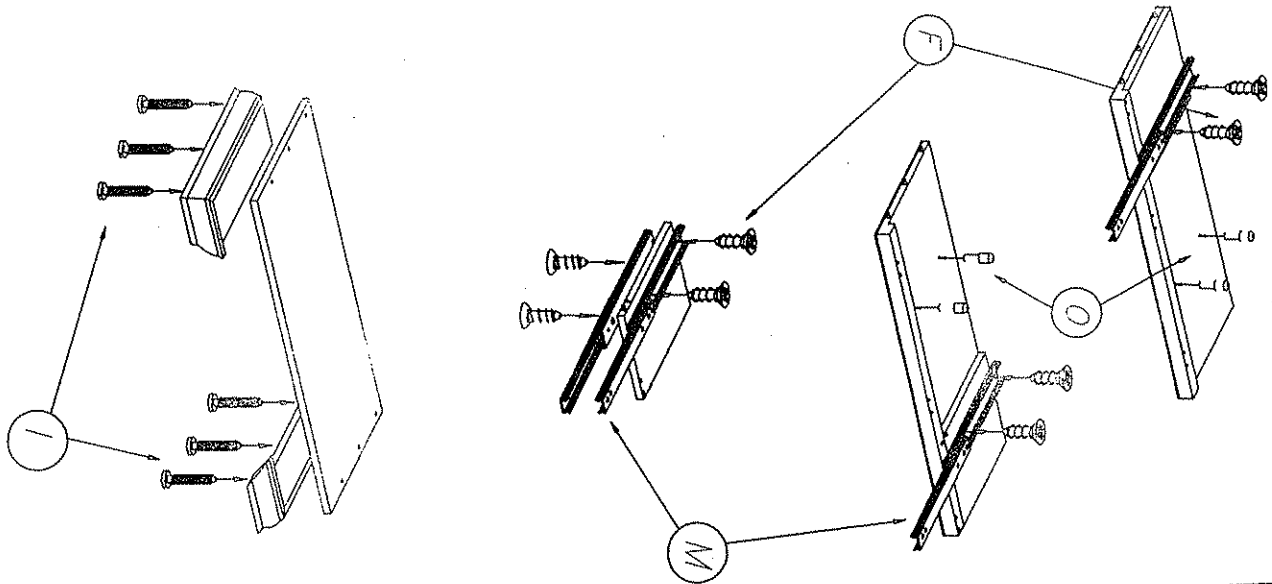

2

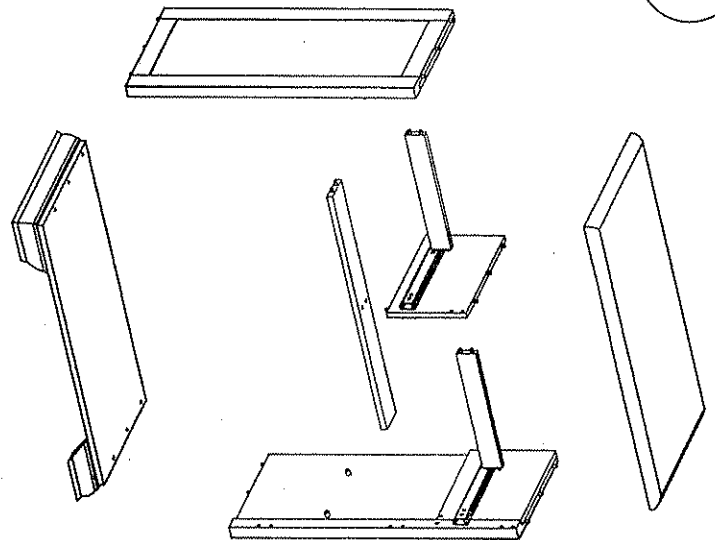

3

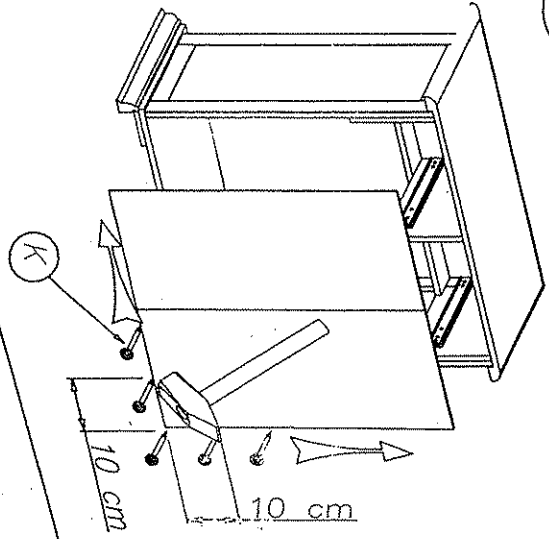

5

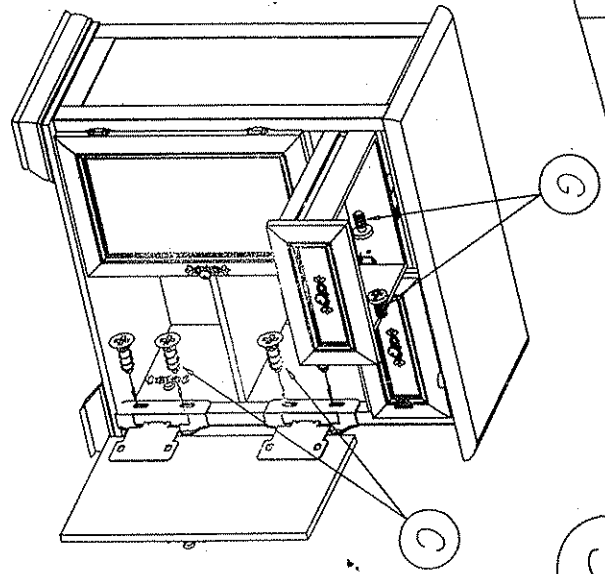

4

