

Modellname: **ATLANTA**  
 Nazwa modelu:

Modellreihe: **31**  
 Numer modelu:

1/2

## MONTAGEANLEITUNG \* INSTRUKCJA MONTAŻOWA

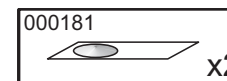
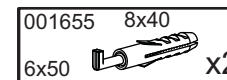
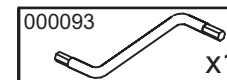
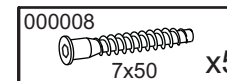
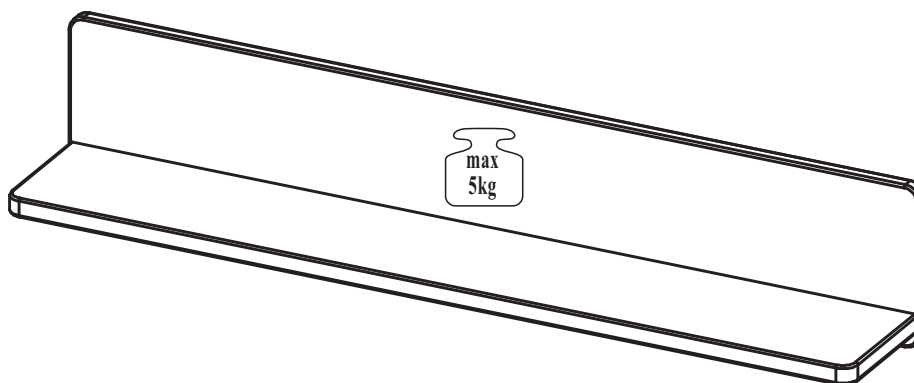
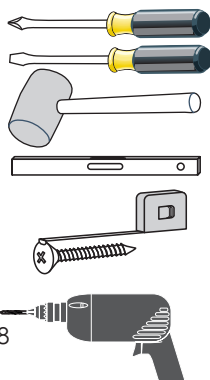

### Pflegehinweis!

Bitte nur mit einem Staubtuch oder einem feuchten Lappen reinigen.

**KEINE** scheuernde Putzmittel verwenden!

### Wskazówka dotycząca pielęgnacji!

Proszę czyścić tylko suchą lub lekko wilgotną szmatką do kurzu. Nie używać żadnych środków szorstkich!

max. zulässige Belastungen von Einlegeböden in Kg: max. dopuszczalne obciążenie półki w Kg:									
Länge dtug.	Stärke obciążenie mm	Massivholz/Masyw			Spanplatte/Płyta			Glas/Sztko	RW mit Boden
		15	18	20	15	18	22	5 / 6 / 8	
0 ≤ 400								Länge bis/ dtug. do 600 mm / 10kg	Länge 1000 mm
401 ≤ 600	20	20	20	15	15	15		Länge bis/ dtug. do 900 mm / 5kg	max 5kg%
601 ≤ 800				10					
801 ≤ 1000	10			5	5				

**1**

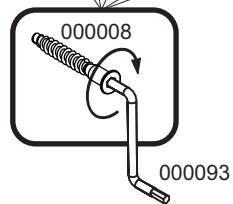
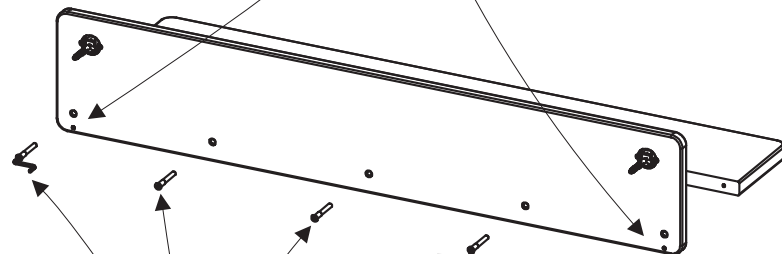
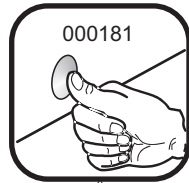
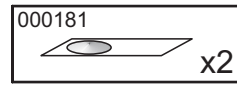
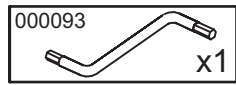
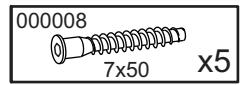

**2**

