

PRZED ROZPOCZĘCIEM MONTAŻU
ZAPOZNAĆ SIĘ Z INSTRUKCJĄ

BRAVO 09

Narzędzia niezbędne do montażu
(nie dostarczane przez producenta)

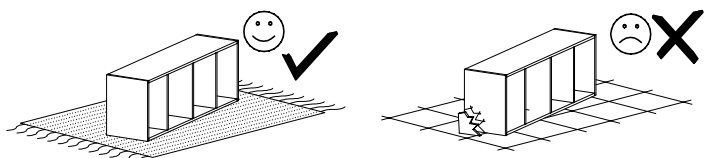
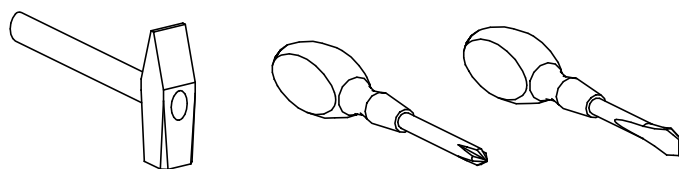

MONTOWAĆ NA MIEKKIM PODŁOŻU TYPU: KOC, DYWAN.

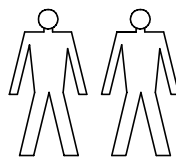

W PRZYPADKU REKLAMACJI PROSZĘ OZNACZYĆ
NUMER SERII OPISANY NA ETYKIECIE OPAKOWANIA

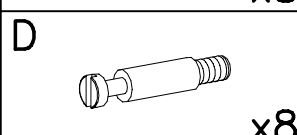
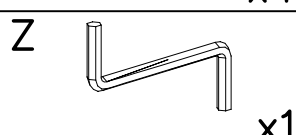
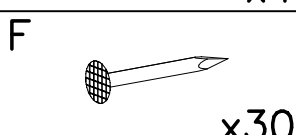
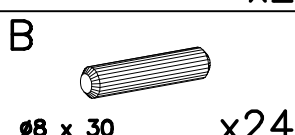
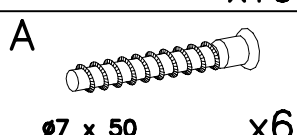
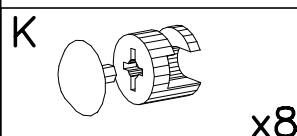
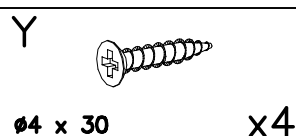
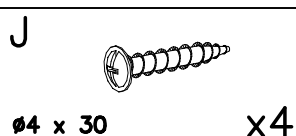
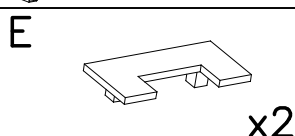
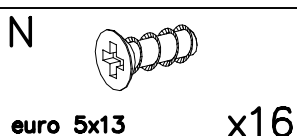
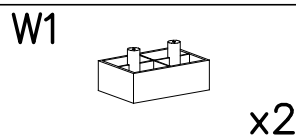
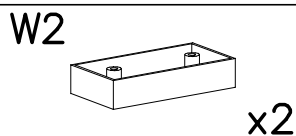
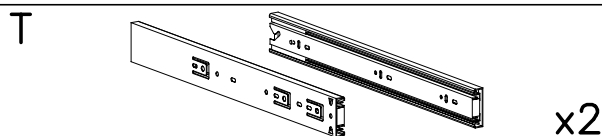
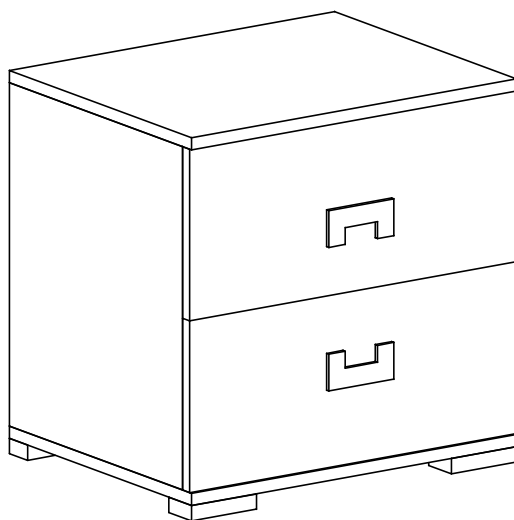

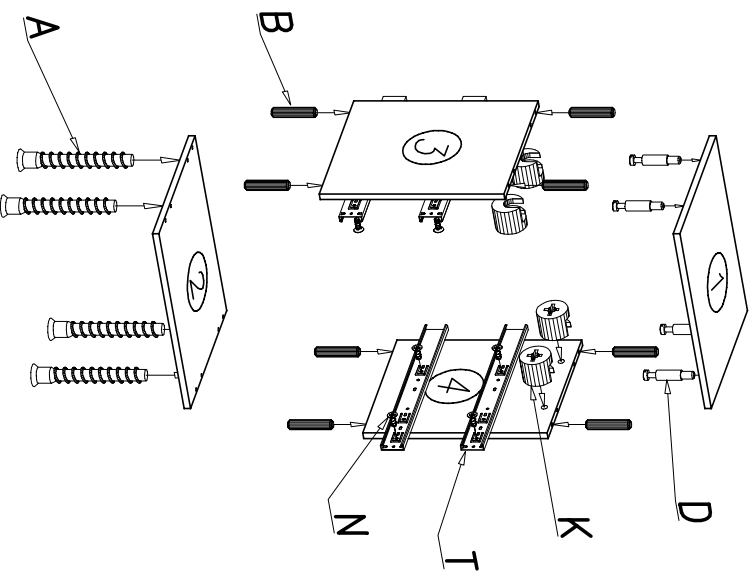
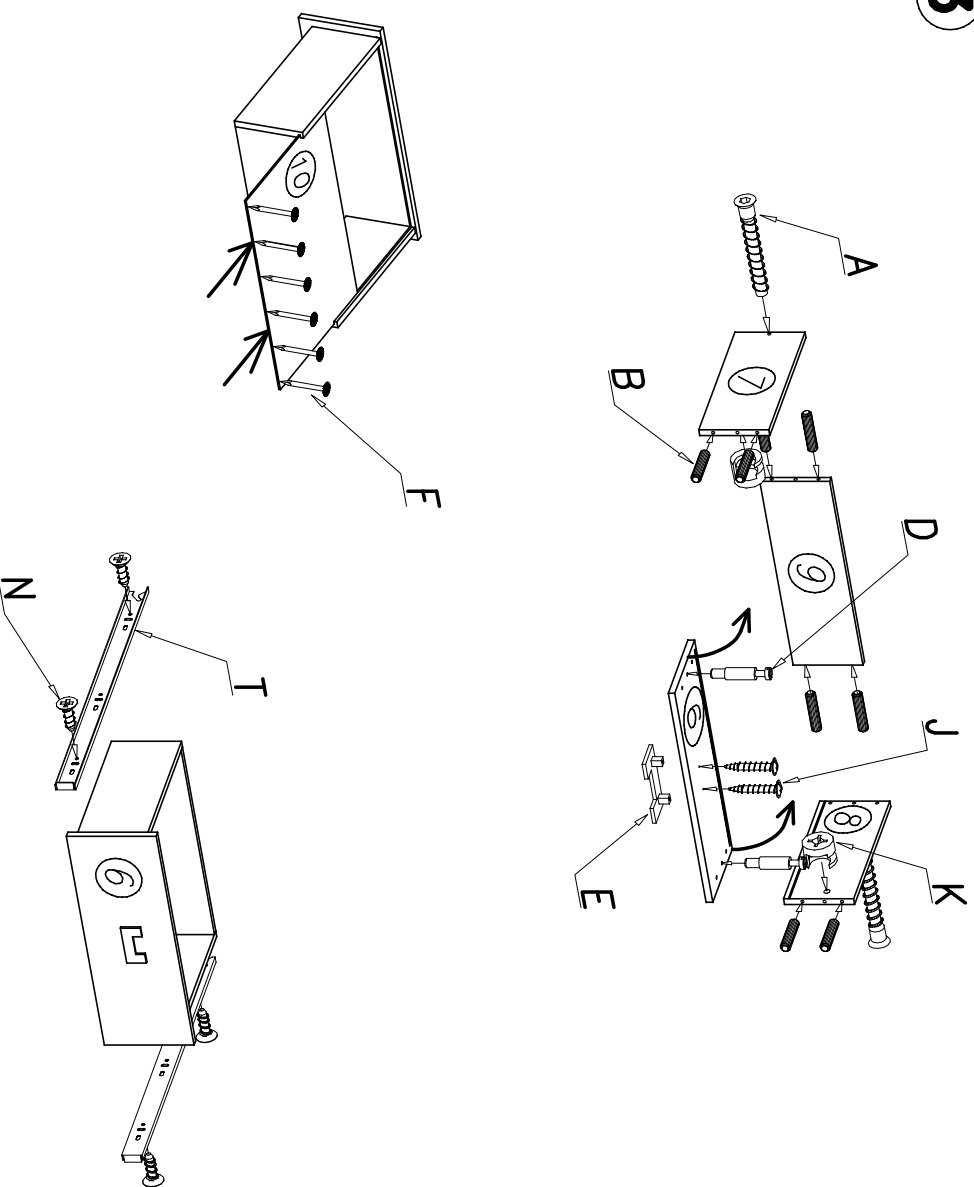
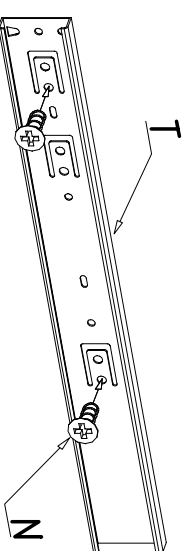
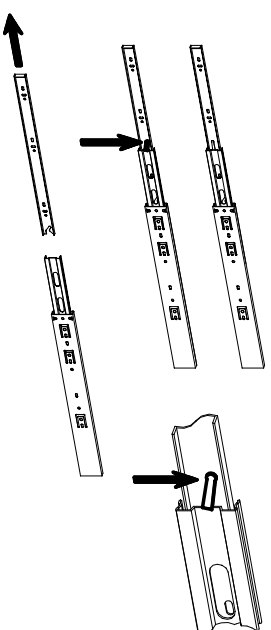
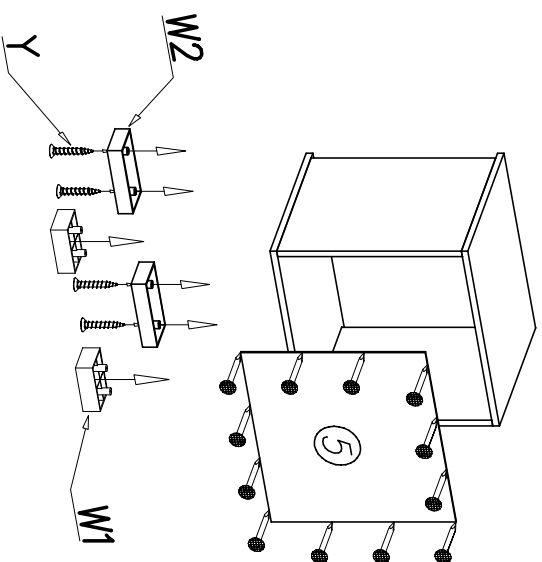
1**3****2**

UWAGA

Kotki nabijając w zaznaczone strzałkami miejscami.

Długość wystającego kotka po wbiciu w otwór nie może przekraczać 9–10mm.