

PRZED ROZPOCZĘCIEM MONTAŻU
ZAPOZNAĆ SIĘ Z INSTRUKCJĄ

BRAVO 08

Narzędzia niezbędne do montażu
(nie dostarczane przez producenta)

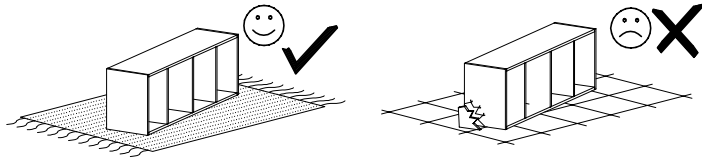
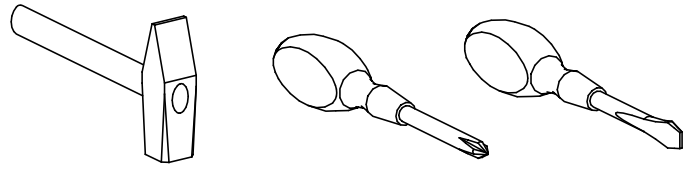

MONTOWAĆ NA MIEKKIM PODŁOŻU TYPU: KOC, DYWAN.

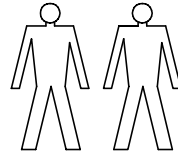

W PRZYPADKU REKLAMACJI PROSZĘ OZNACZYĆ
NUMER SERII OPISANY NA ETYKIECIE OPAKOWANIA

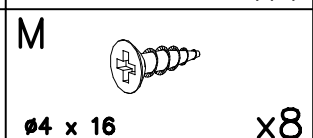
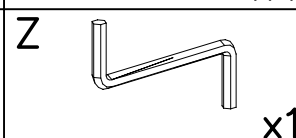
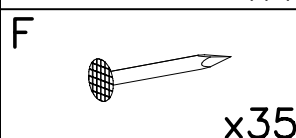
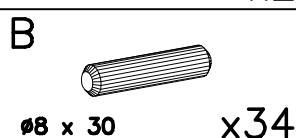
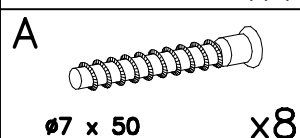
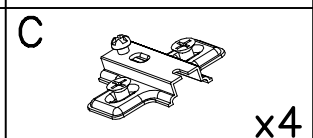
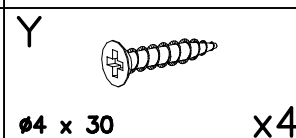
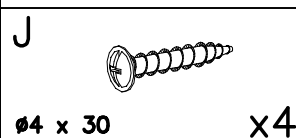
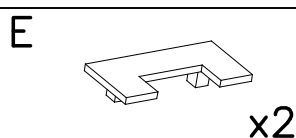
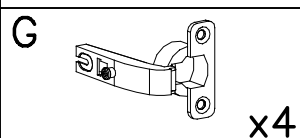
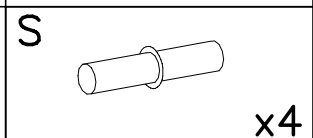
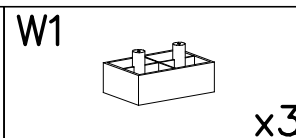
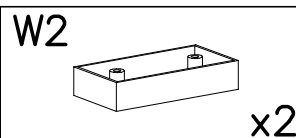
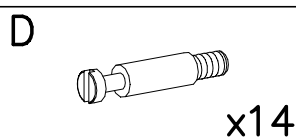
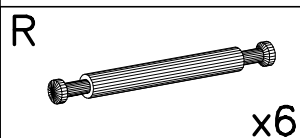
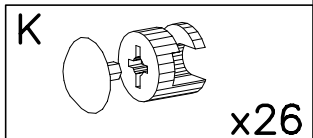
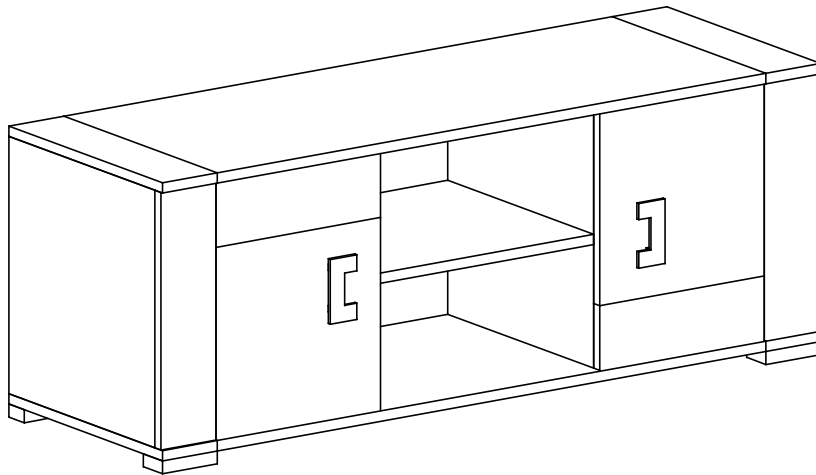

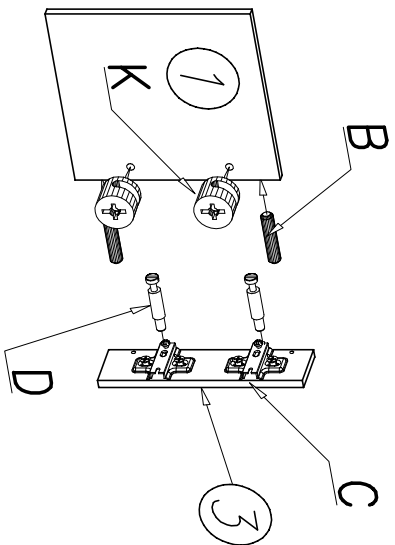
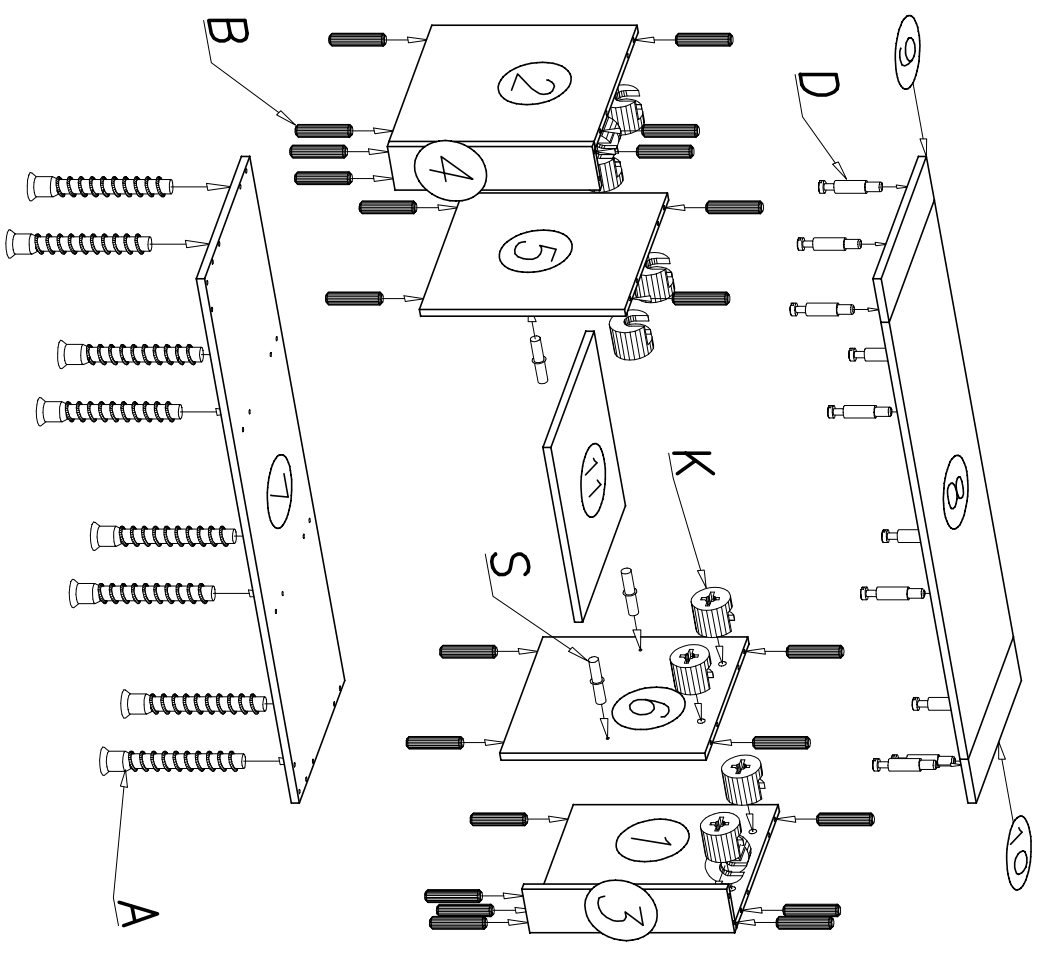
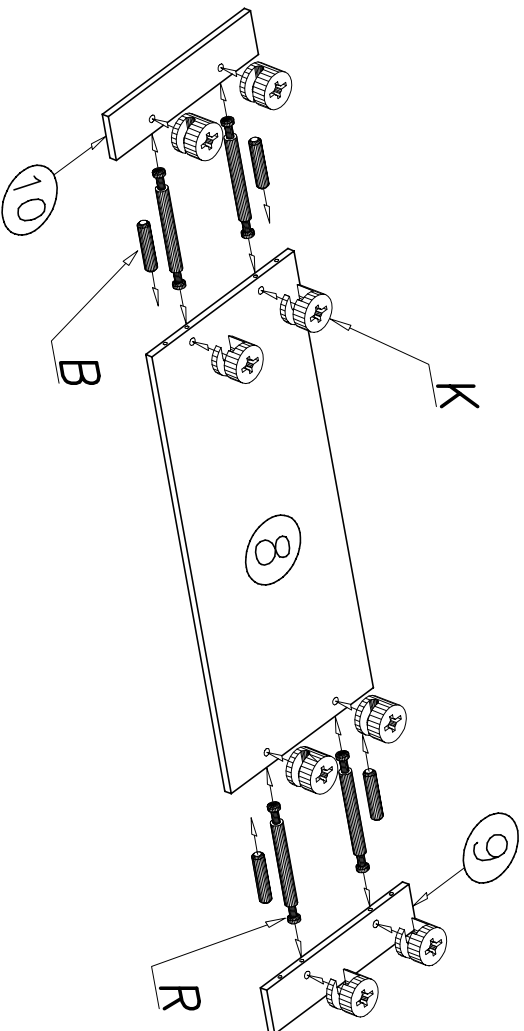
1**3****2**

UWAGA

Końki nabijając w zaznaczone strzałkami miejscami.

Długość wystającego kołka po wbiciu w otwór nie może przekraczać 9–10mm.

4

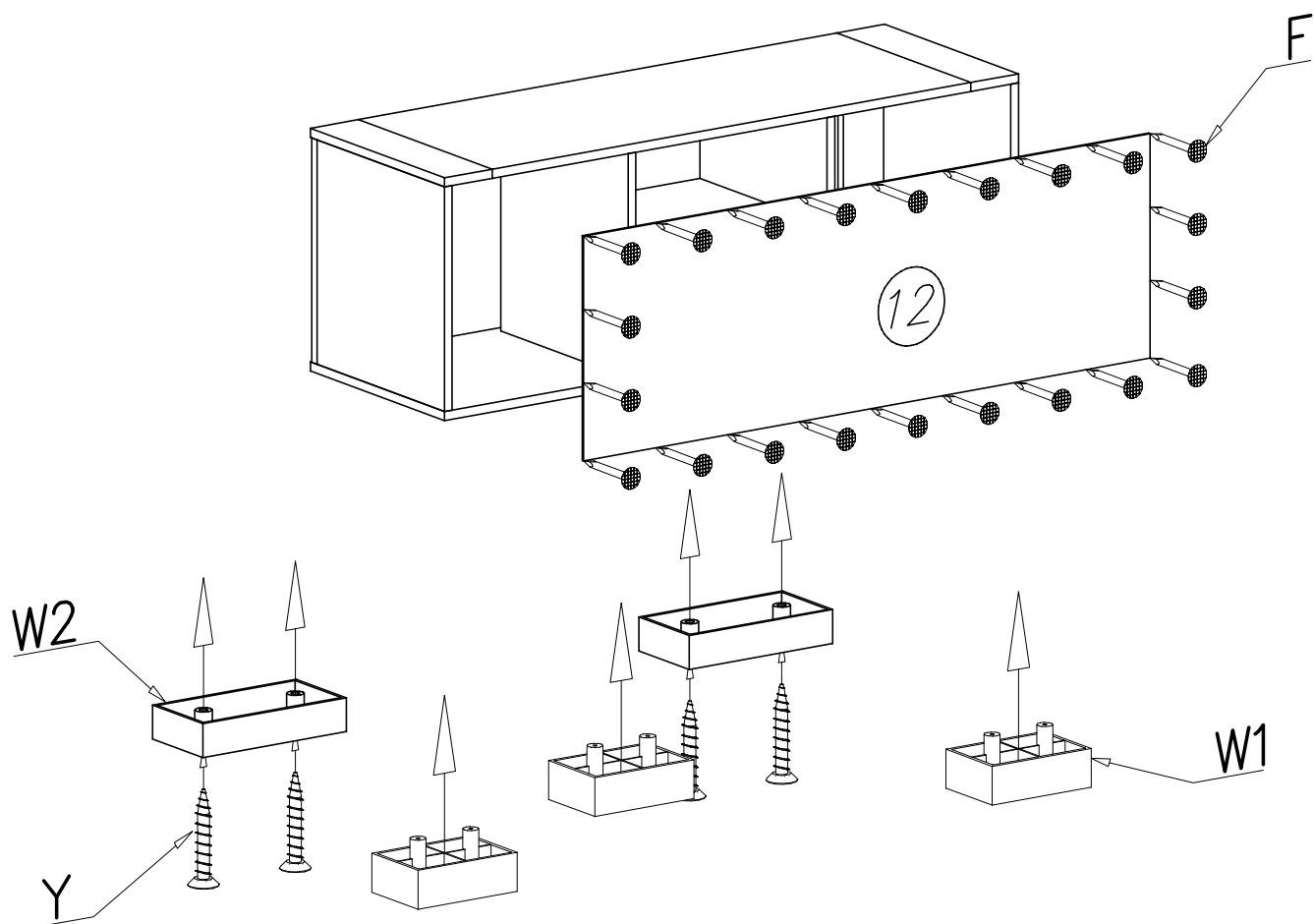

5

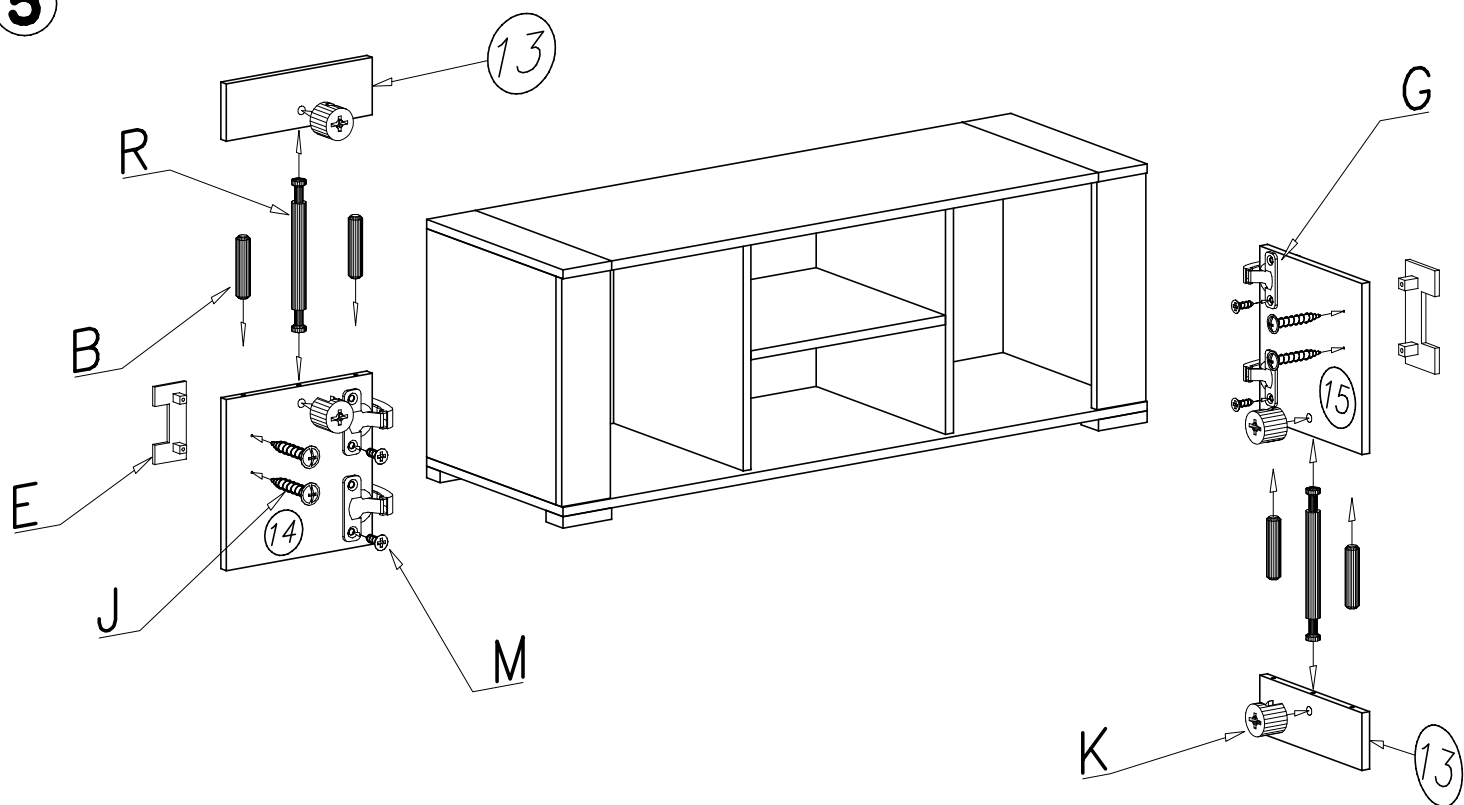

UWAGA

Kółki nabijać w zaznaczone strzałkami miejsca.

Długość wystającego kołka po wbiciu w otwór nie może przekraczać 9–10mm.