

PRZED ROZPOCZĘCIEM MONTAŻU
ZAPOZNAĆ SIĘ Z INSTRUKCJĄ

regał 40

Narzędzia niezbędne do montażu
(nie dostarczane przez producenta)

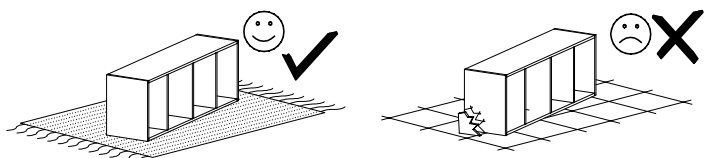
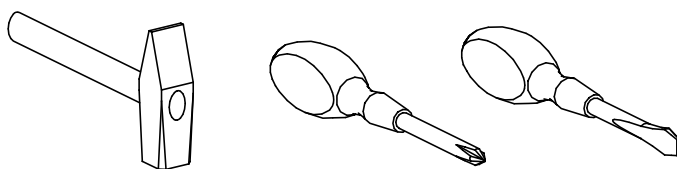

MONTOWAĆ NA MIEKKIM PODŁOŻU TYPU: KOC, DYWAN.

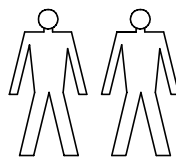

W PRZYPADKU REKLAMACJI PROSZĘ OZNACZYĆ
NUMER SERII OPISANY NA ETYKIECIE OPAKOWANIA

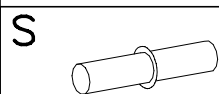
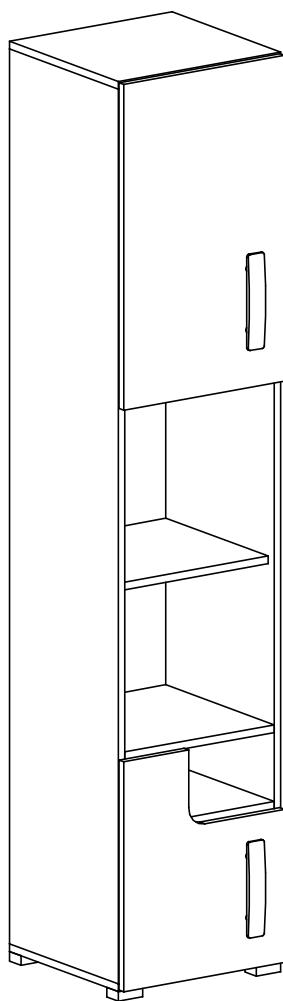

x8

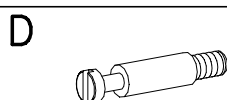

x12

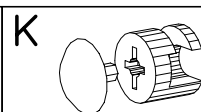

x12

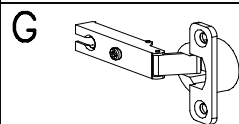

x4



x2

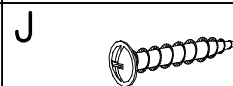

ø4 x 30

x4

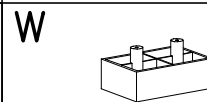

x4

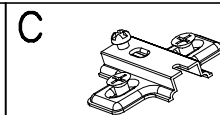

x4

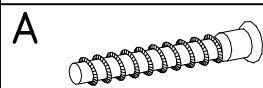

ø7 x 50

x8

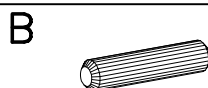

ø8 x 30

x20

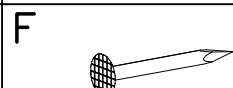

x45

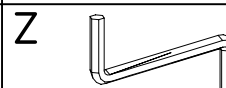

x1

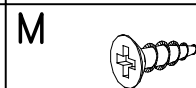

ø4 x 16

x8

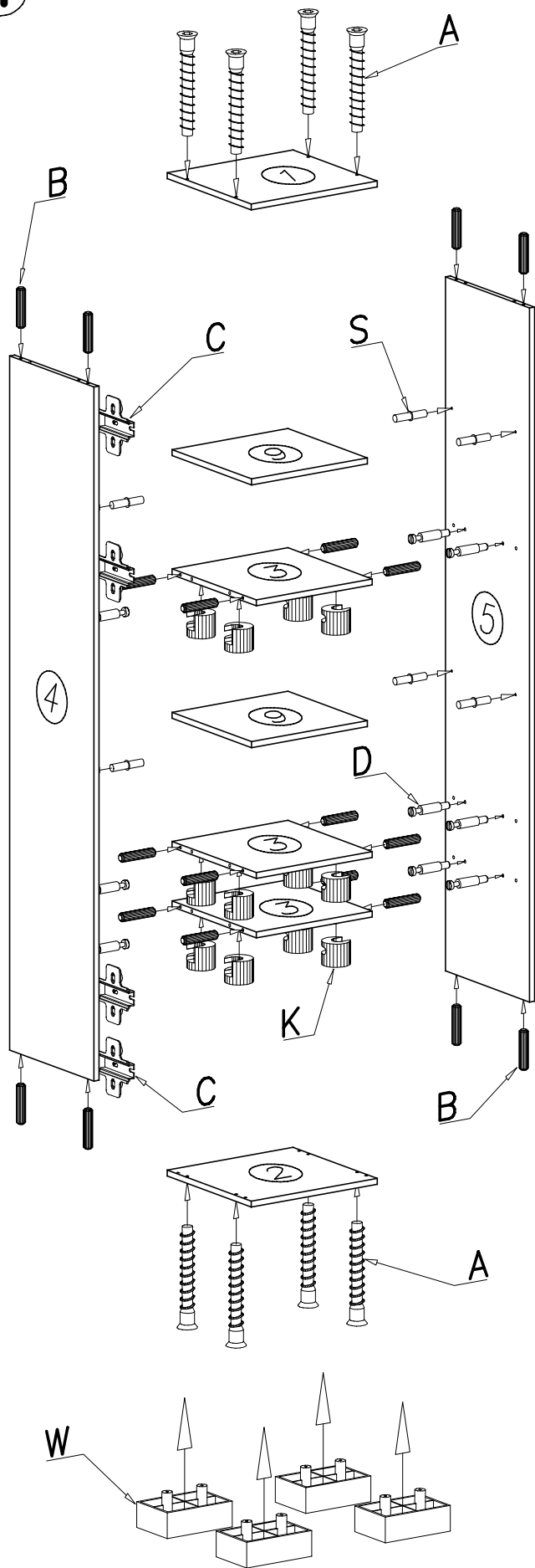
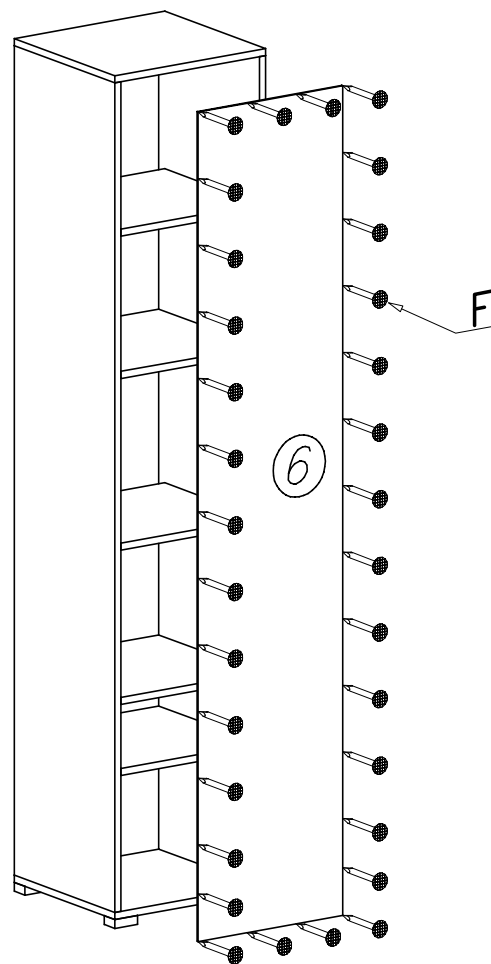
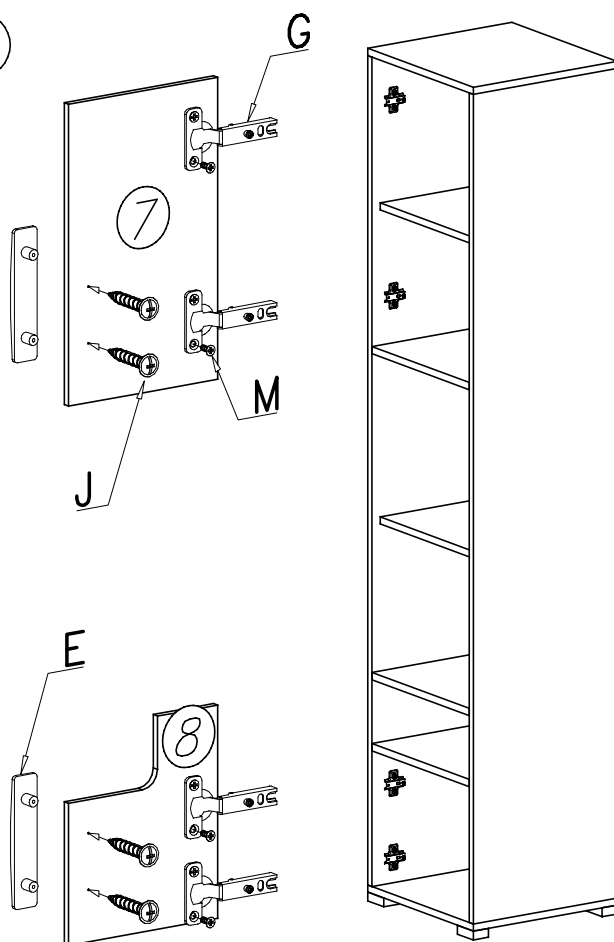
1**2****3****UWAGA**

Kołki nabijać w zaznaczone strzałkami miejsca.

Długość wystającego kołka po wbiciu w otwór nie może przekraczać 9–10mm.