

PRZED ROZPOCZĘCIEM MONTAŻU
ZAPOZNAĆ SIĘ Z INSTRUKCJĄ

regał 80

Narzędzia niezbędne do montażu
(nie dostarczane przez producenta)

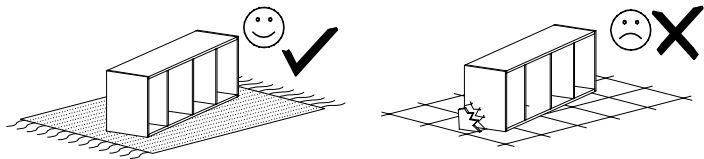
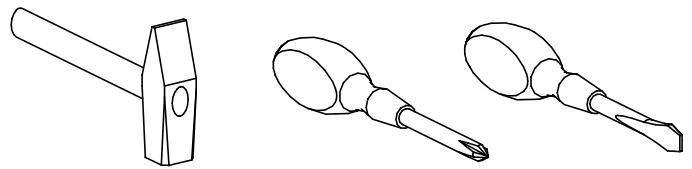

MONTOWAĆ NA MIEKKIM PODŁOŻU TYPU: KOC, DYWAN.

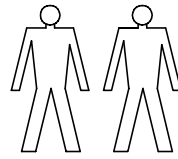

W PRZYPADKU REKLAMACJI PROSZĘ OZNAČYĆ
NUMER SERII OPISANY NA ETYKIECIE OPAKOWANIA

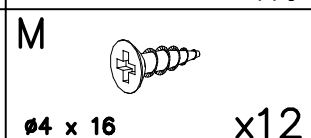
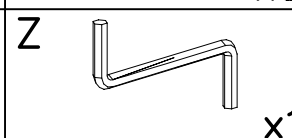
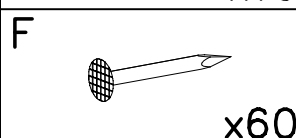
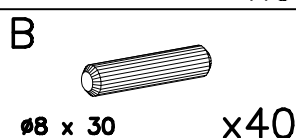
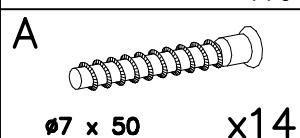
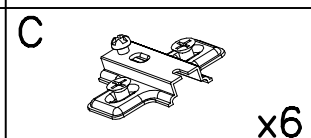
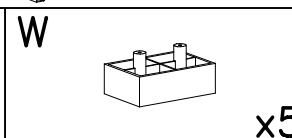
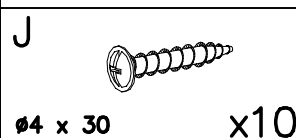
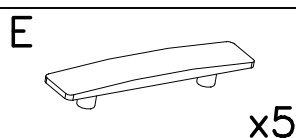
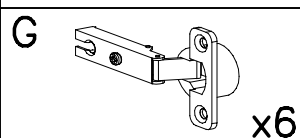
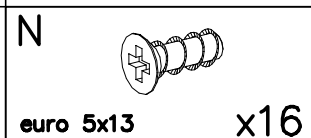
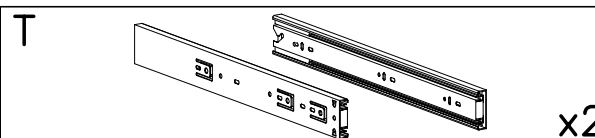
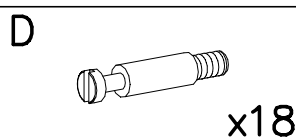
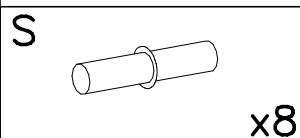
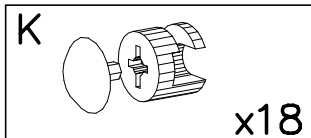
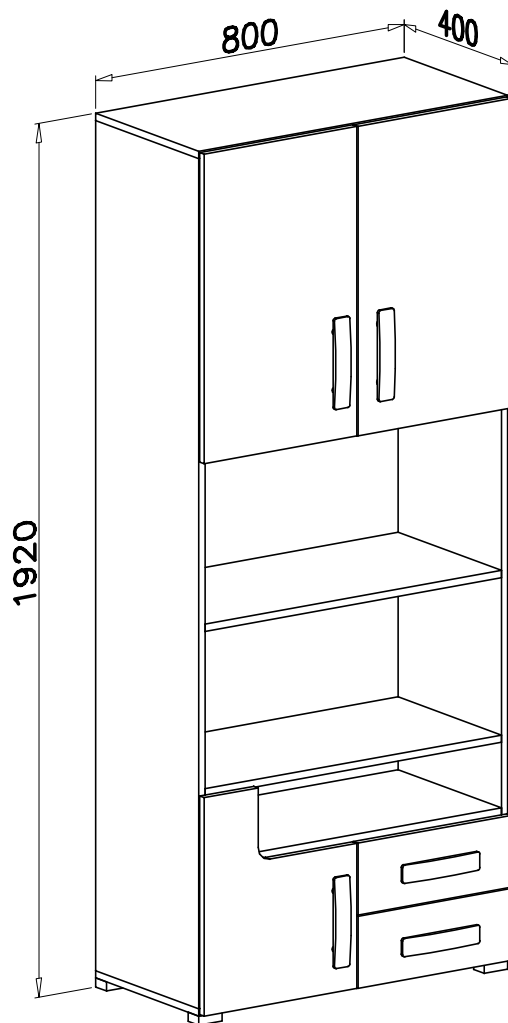

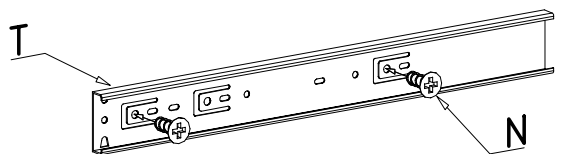
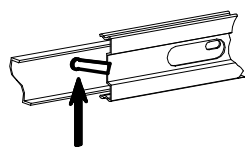
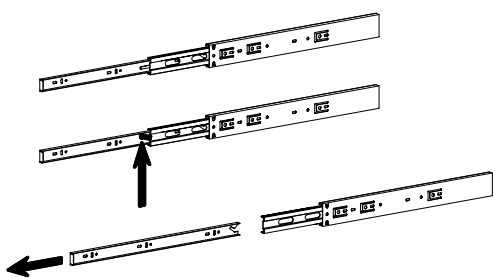
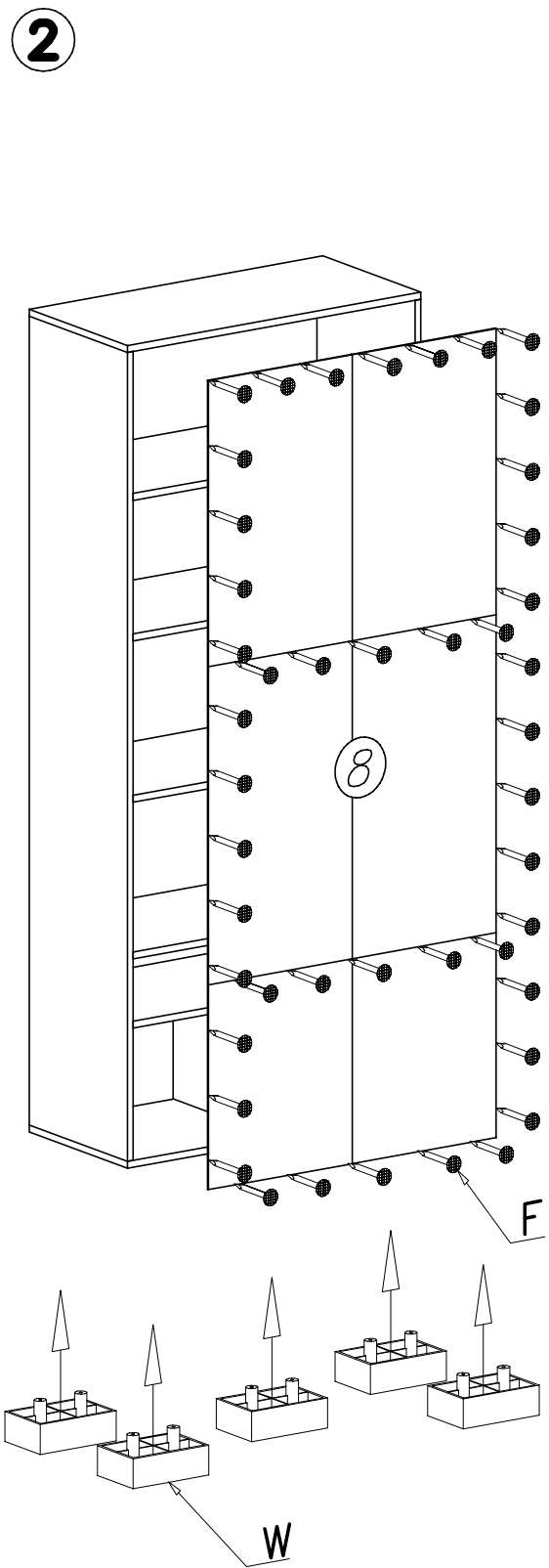
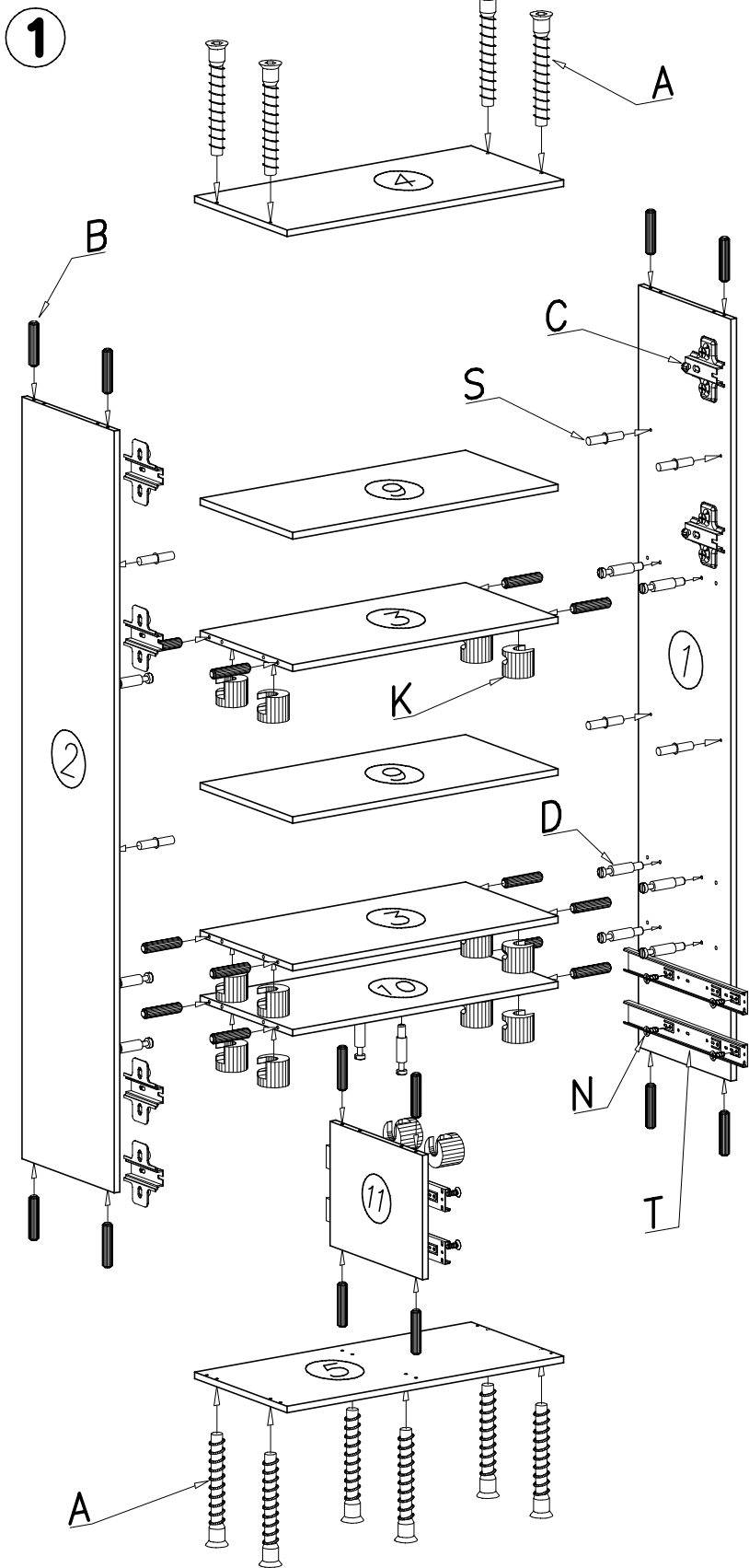

UWAGA

Kotki nabijać w zaznaczone strzałkami miejsca.

Długość wystającego kotka po wbiciu w otwór nie może przekraczać 9–10mm.

3

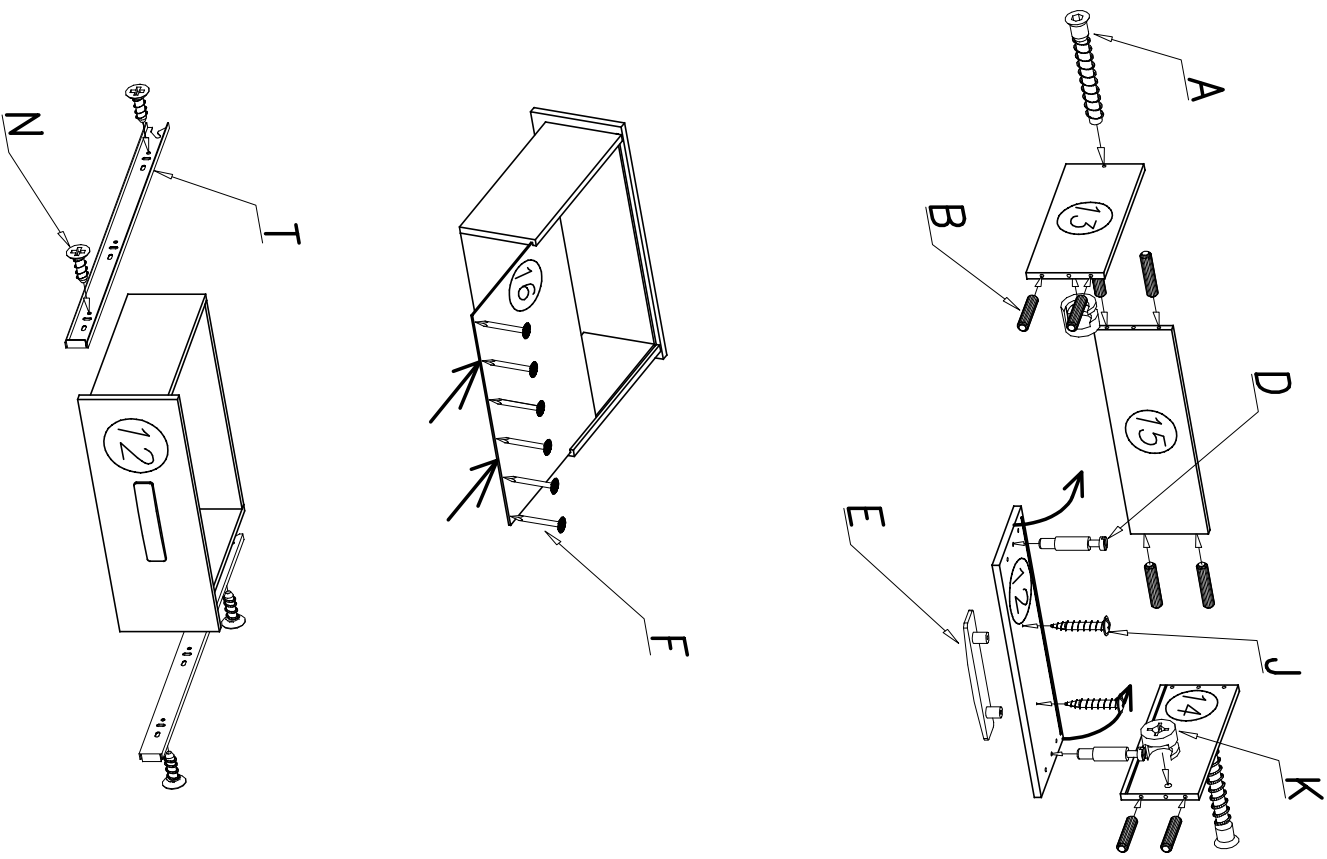

4

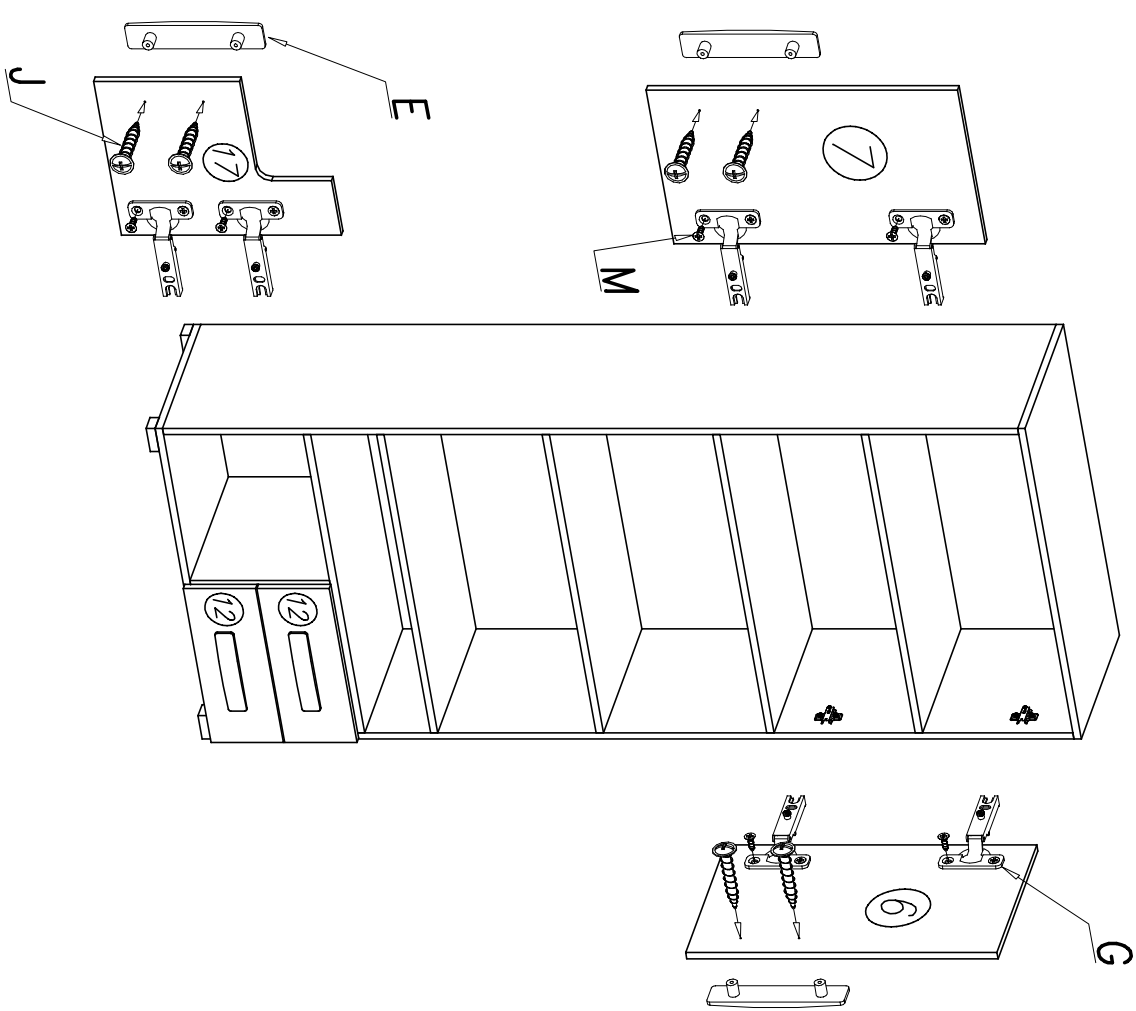

UWAGA

Kotki nabijając w zaznaczone strzałkami miejscami.
 Długość wystającego kotka po wbiciu w otwór nie może przekraczać 9–10mm.