

PRZED ROZPOCZĘCIEM MONTAŻU ZAPOZNAĆ SIĘ Z INSTRUKCJĄ

Narzędzia niezbędne do montażu (nie dostarczane przez producenta)

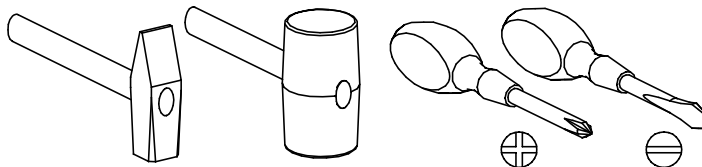

ROMERO

06

Nr	Nazwa elementu	Dł [mm]	Szer [mm]	Gr [mm]	Ilość	Kod	Paczka
1	blat górny	350	320	16	1		
2	blat dolny	350	320	16	1		
3	wieniec	317	298	16	4		
4	drzwi	1704	345	16	1		
5	HDF ściana tylna	1730	338	2,5	1		
6	bok	1710	301	16	2		

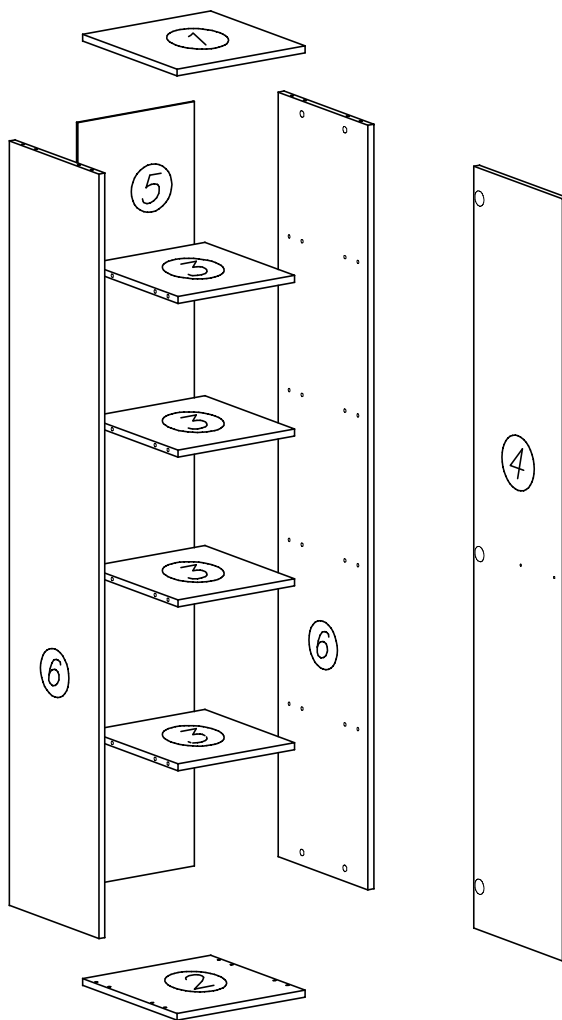
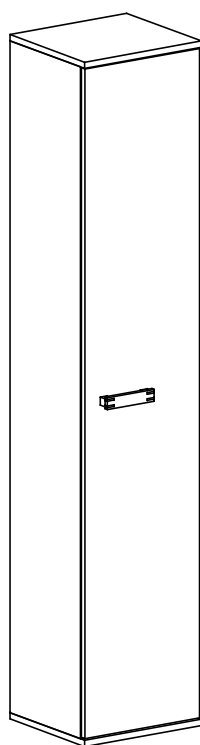

G34 
3,5 x 16 x6

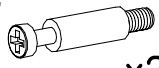
K5 
x24

K1 
ø15 x 12 x24

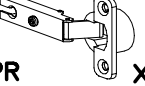
C3 
Z35PR x3

D3 
PZ35PR x3

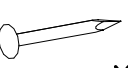
W4 
x50

P5 
x4

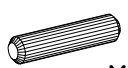
B1 
x24

N26 
M4 x 45 x2

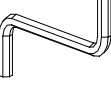
W2 
x1

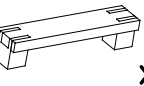
E12 
x1

I

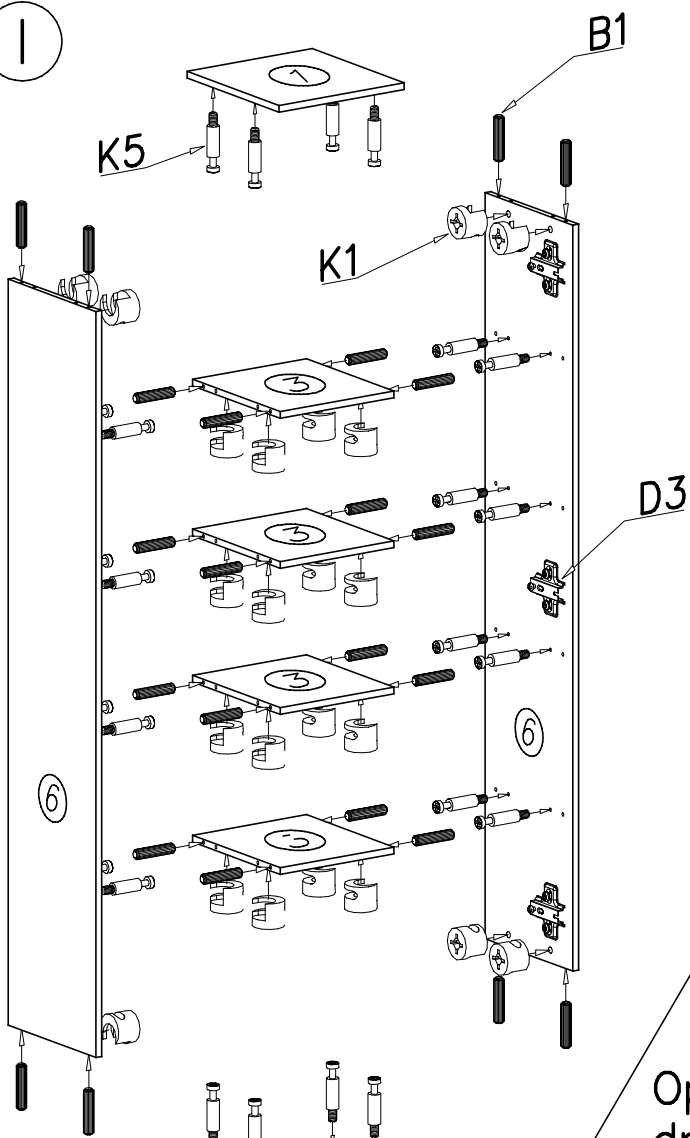

II

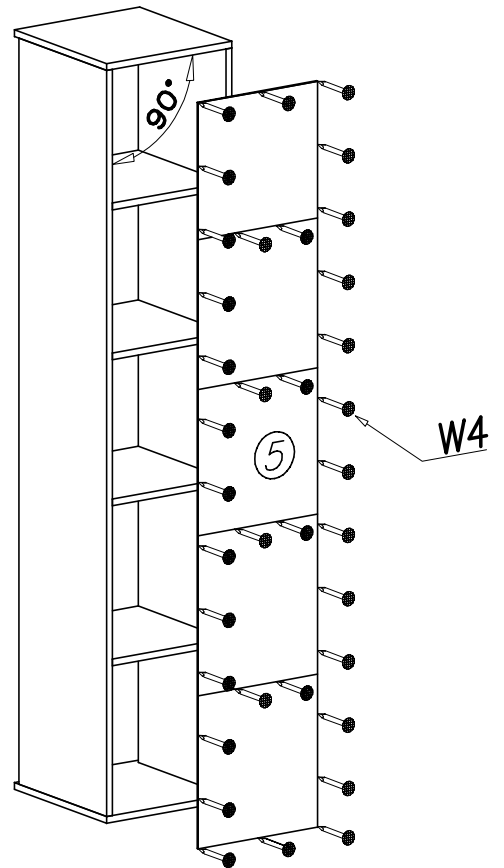

III

Opcja: drzwi lewe

Opcja: drzwi prawe

