

PRZED ROZPOCZĘCIEM MONTAŻU ZAPOZNAĆ SIĘ Z INSTRUKCJĄ

Narzędzia niezbędne do montażu (nie dostarczane przez producenta)

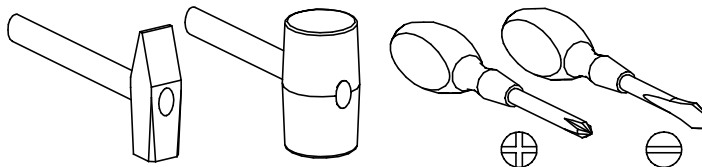

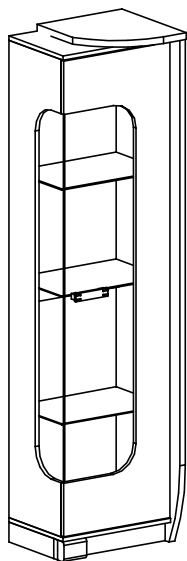

ROMERO

02P



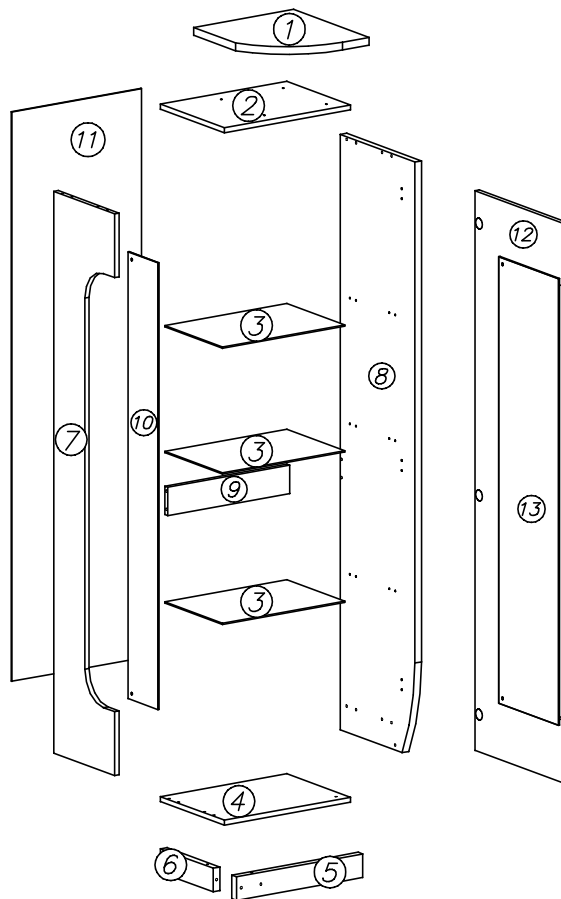

Nr	Nazwa elementu	Dł [mm]	Szer [mm]	Gr [mm]	Ilość	Kod	Paczka
1	blat górny	375	460	25	1		
2	wieniec górny	474	397	16	1		
3	półka szklana	450	365	4	3		
4	wieniec dolny	474	397	16	1		
5	cokół przedni	474	74	25	1		
6	cokół boczny	344	74	25	1		
7	bok lewy	1787	381	16	1		
8	bok prawy	1894	455	25	1		
9	łąącznik	458	90	16	1		
10	szyba bok	1461	211	4	1		
11	HDF sciana tylna	1820	480	2,5	1		
12	drzwi	1781	469	16	1		
13	szyba front	1461	313	4	1		



G2 
3 x 20 x8

I2 
x8

W4 
x50

A1 
ø7 x 50 x2

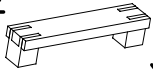
E12 
x1

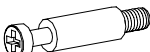
K5 
x10

G6 
3 x 13 x4

G34 
3,5 x 16 x28

K1 
ø15 x 12 x10

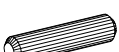
B1 
x18

P5 
x6

D4 
PZ350D x3

G9 
4 x 35 x4

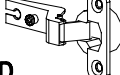
C4 
Z350D x3

P27 
x1

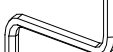
W2 
x1

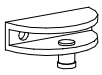
F8 
x9

I3 
x6

N27 
M4 x 30 x2

I

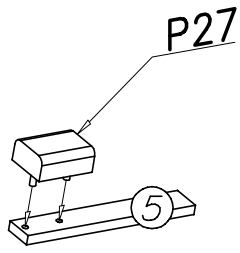

II

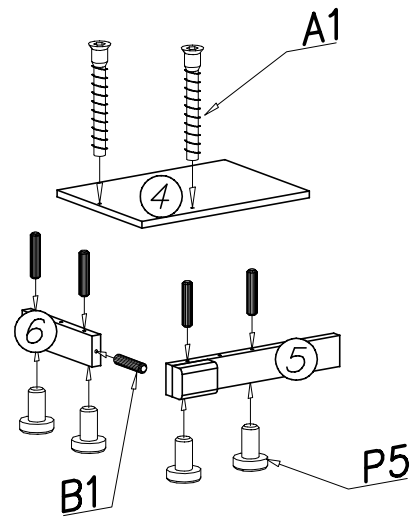

III

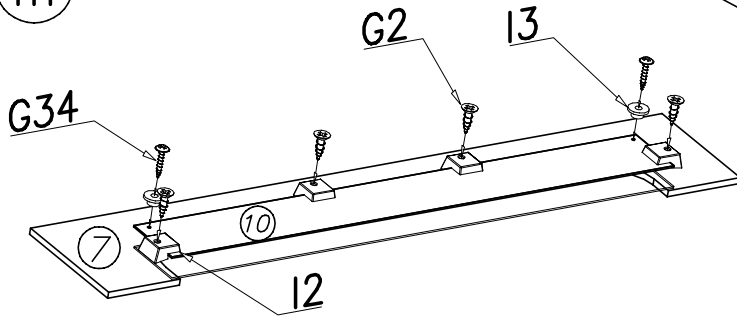

IV

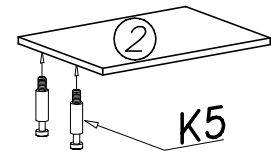

V

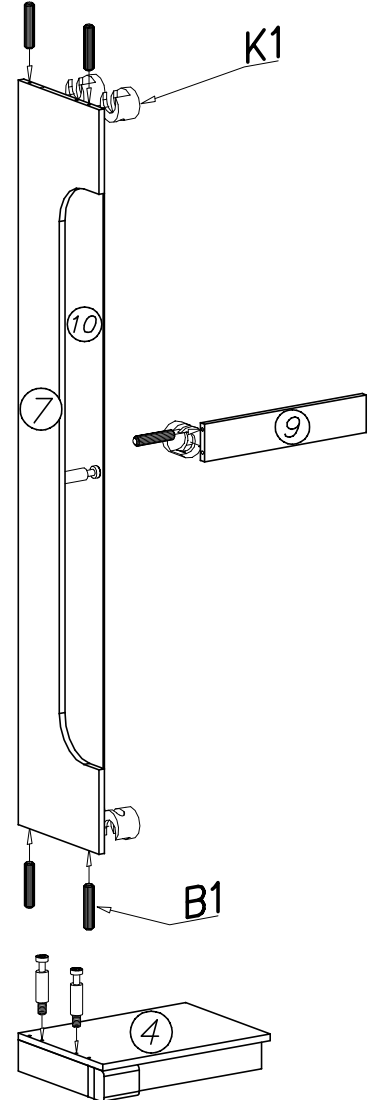
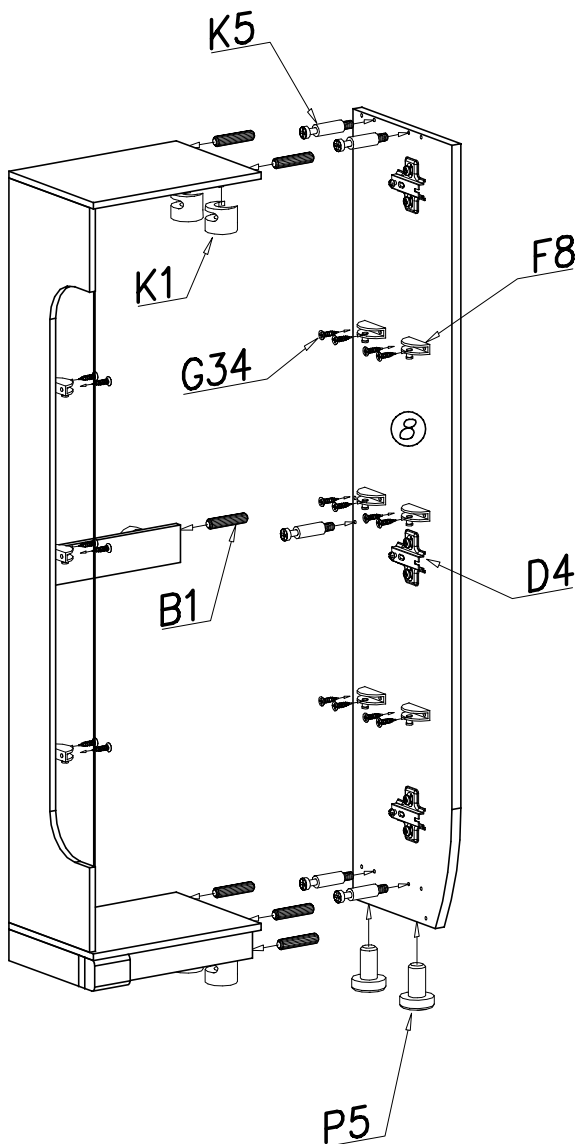

VI

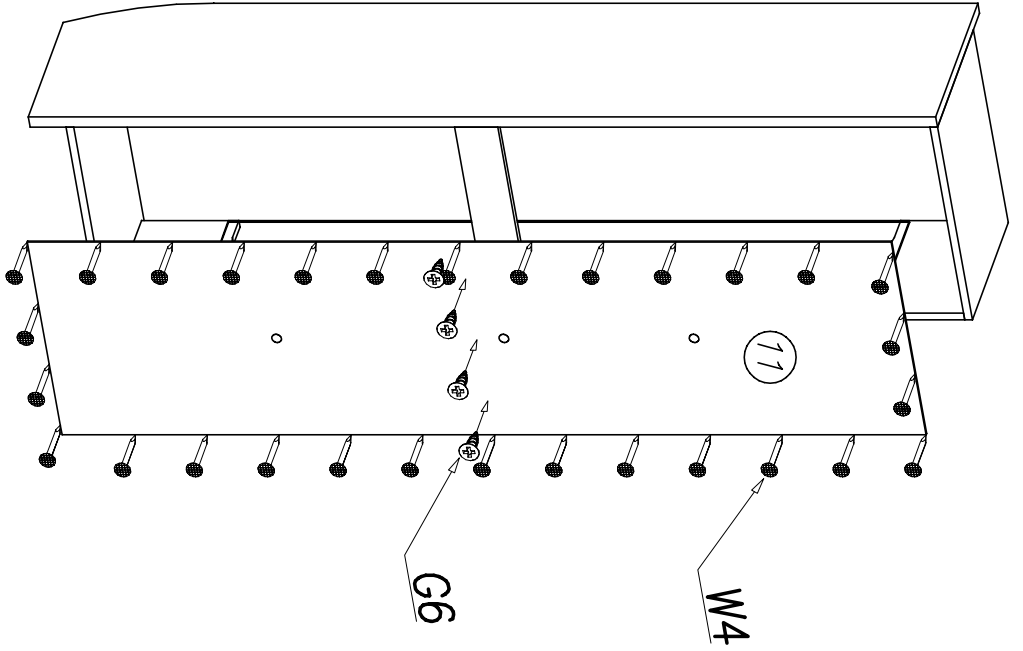

VIII

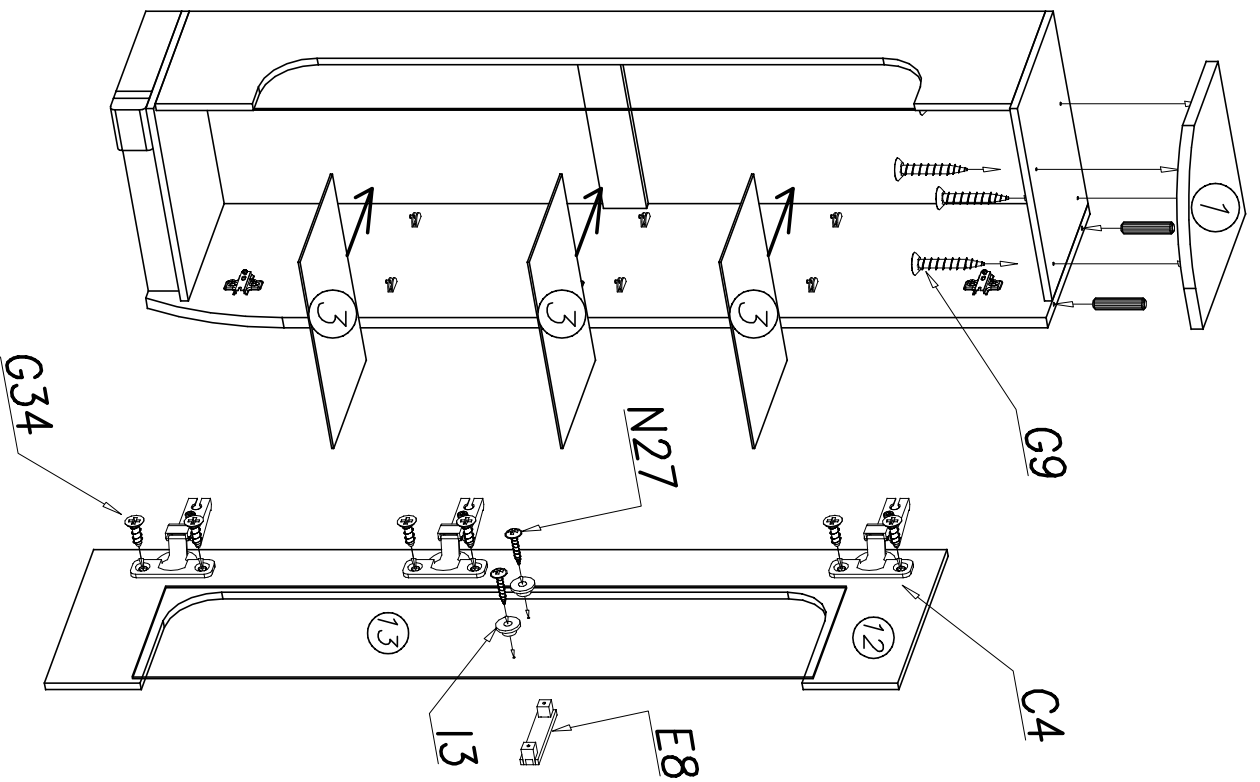

VII

