

PRZED ROZPOCZĘCIEM MONTAŻU ZAPOZNAĆ SIĘ Z INSTRUKCJĄ

Narzędzia niezbędne do montażu (nie dostarczane przez producenta)

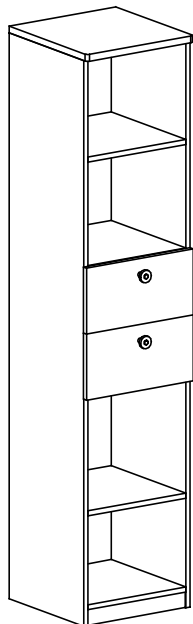
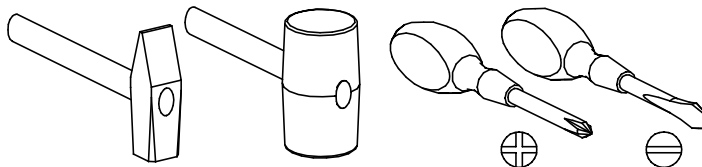

NUKI

Nu-4

Nr	Nazwa elementu	Dł [mm]	Szer [mm]	Gr [mm]	Ilość	Kod	Paczka
1	blat górny	400	417	22	1		
2	bok lewy	1800	400	16	1		
3	bok prawy	1800	400	16	1		
4	wieniec dolny	367	397	16	1		
5	wieniec środkowy	367	397	16	1		
6	HDF ściana tylna	1760	388	2,5	1		
7	cokół	367	50	16	1		
8	front szuflady	396	210	16	1		
9	bok szuflady lewy	350	140	16	2		
10	bok szuflady prawy	350	140	16	2		
11	tył szuflady	309	120	16	2		
12	HDF dno szuflady	356	327	2,5	2		
13	front szuflady	396	210	16	1		
14	półka	367	397	16	2		

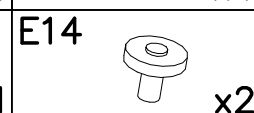
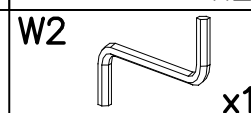
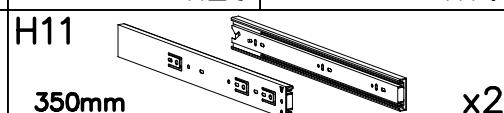
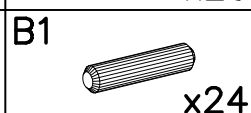
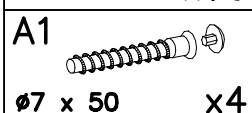
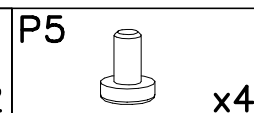
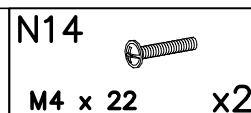
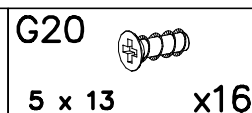
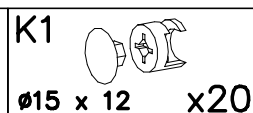
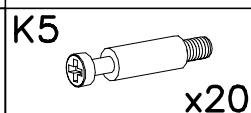
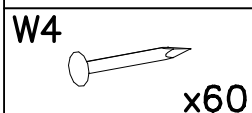
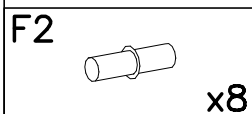
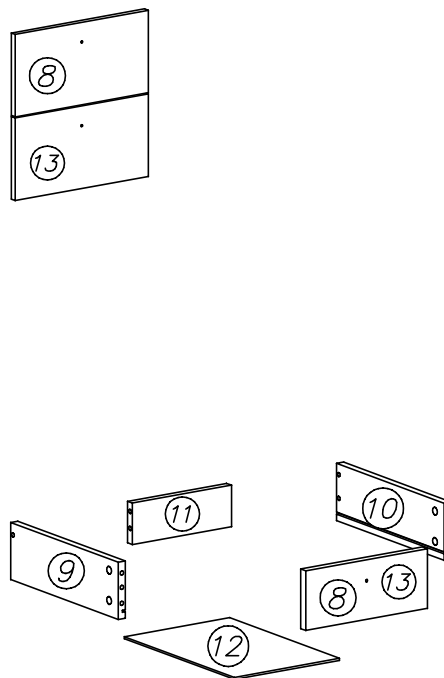
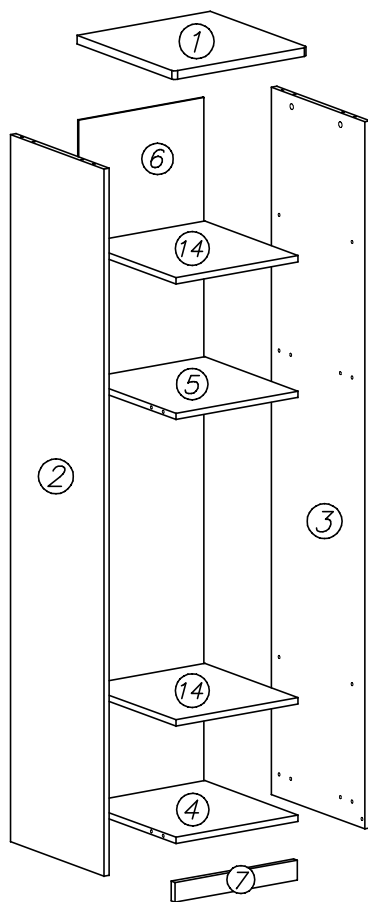

I

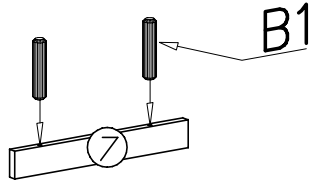

III

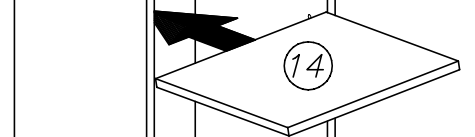
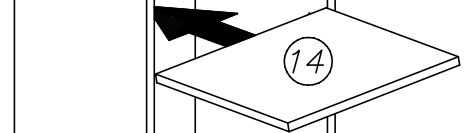
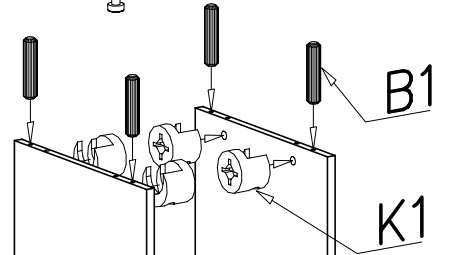
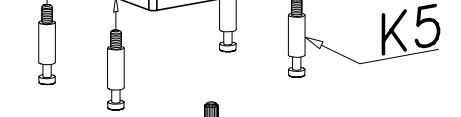
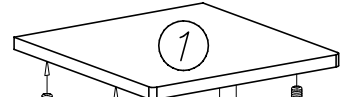

II

