

PRZED ROZPOCZĘCIEM MONTAŻU ZAPOZNAĆ SIĘ Z INSTRUKCJĄ

Narzędzia niezbędne do montażu (nie dostarczane przez producenta)

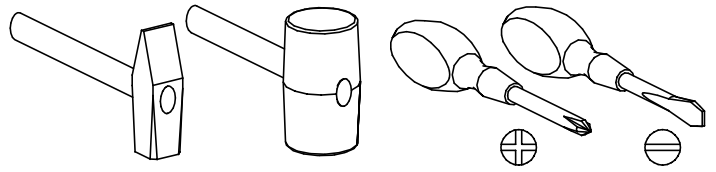

LORENTO 06

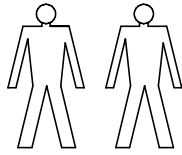
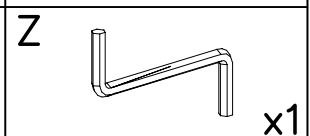
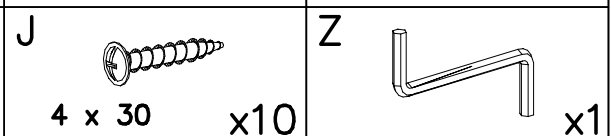
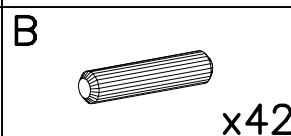
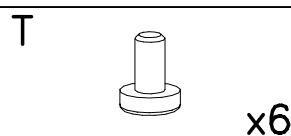
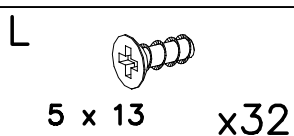
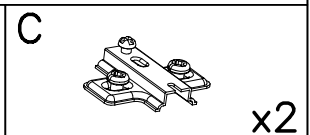
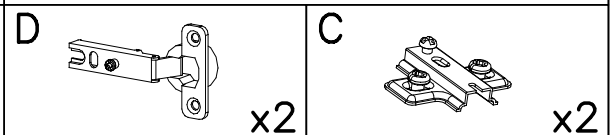
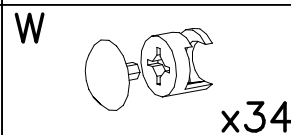
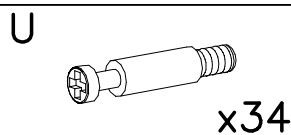
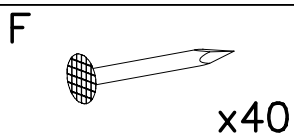
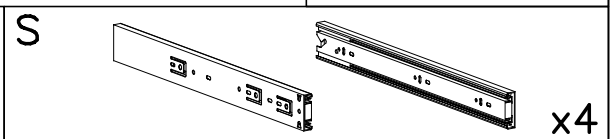
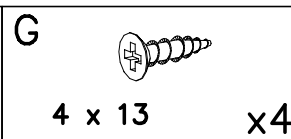
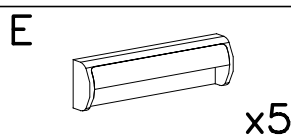
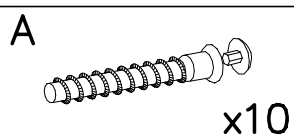
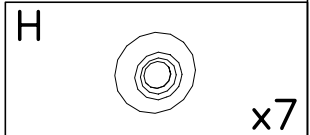
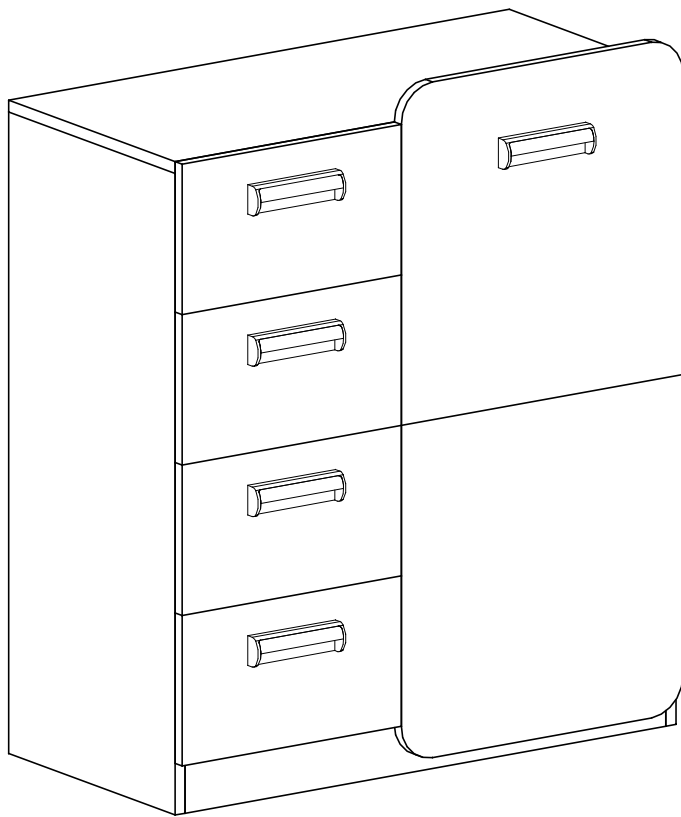

I

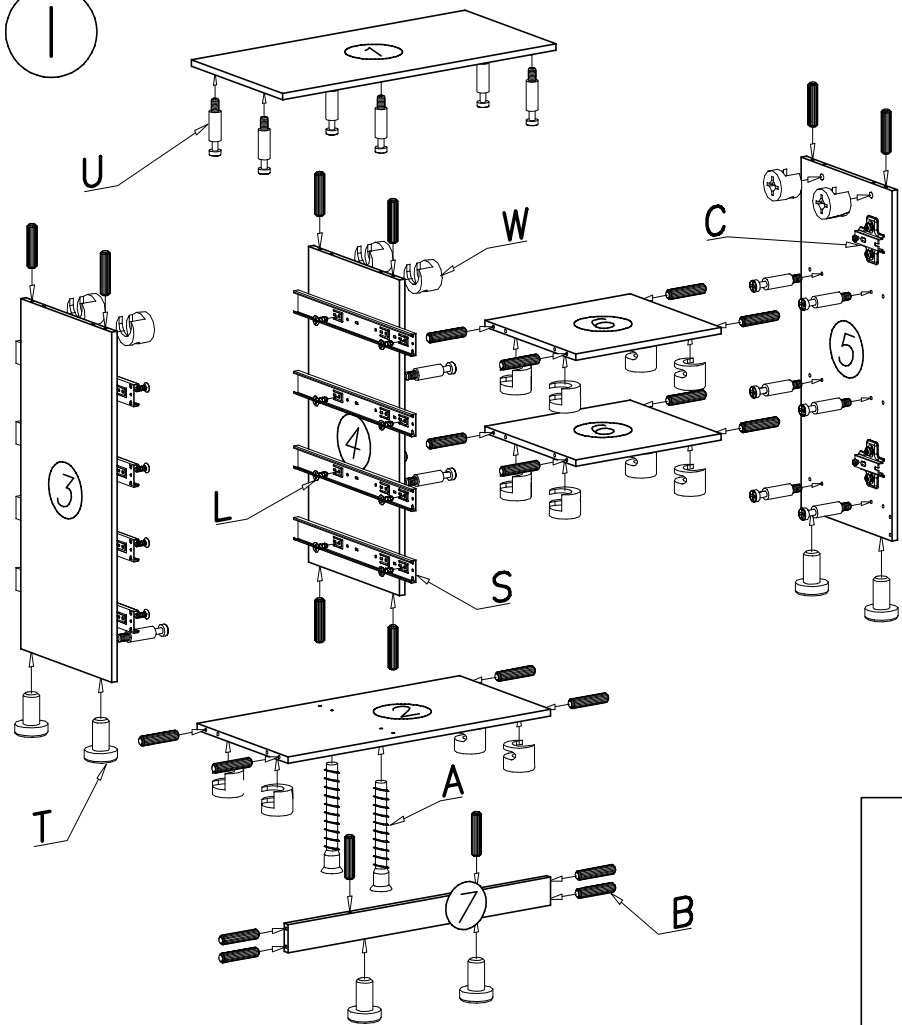

II

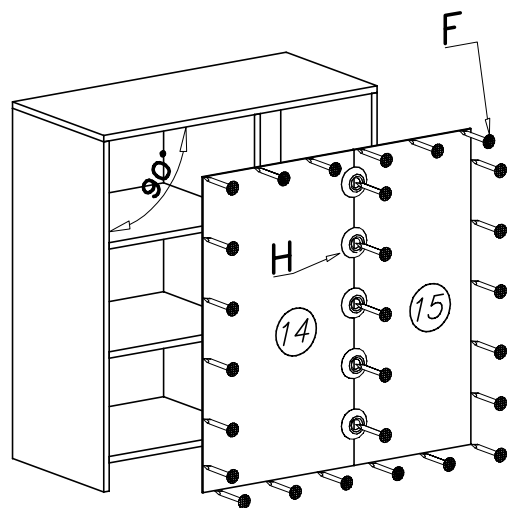

III

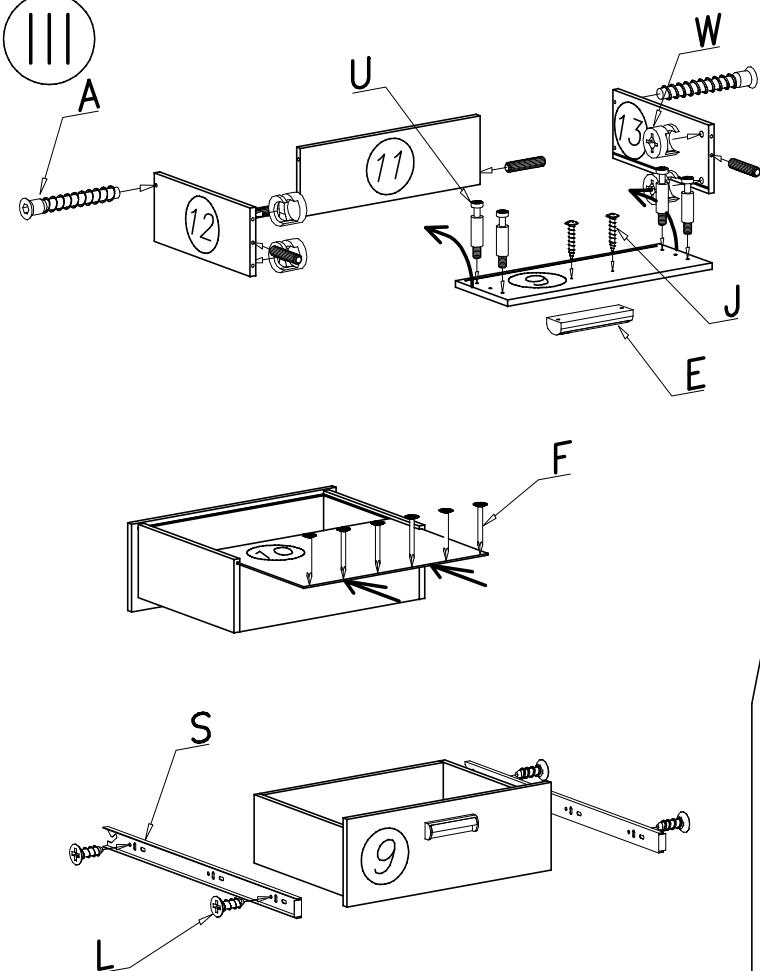

IV

