

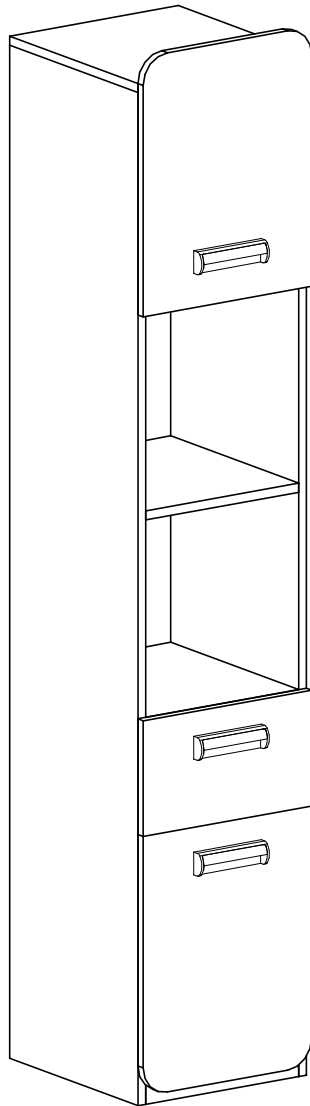

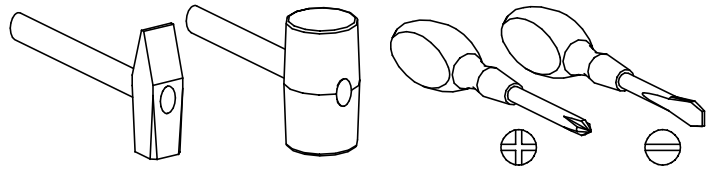

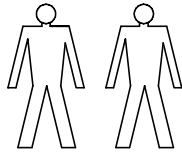

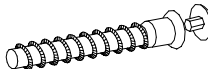

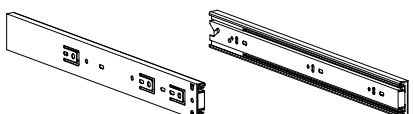
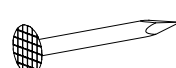
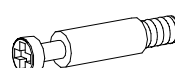

PRZED ROZPOCZĘCIEM MONTAŻU ZAPOZNAĆ SIĘ Z INSTRUKCJĄ

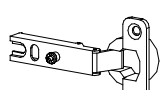
Narzędzia niezbędne do montażu (nie dostarczane przez producenta)

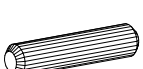

LORENTO 03

A  x2	E  x3	G  4 x 13 x8	S  x1	
F  x40	U  x24	W  x24	D  x4	C  x4
L  5 x 13 x8	T  x4	B  x28	J  4 x 30 x6	Z  x1

I

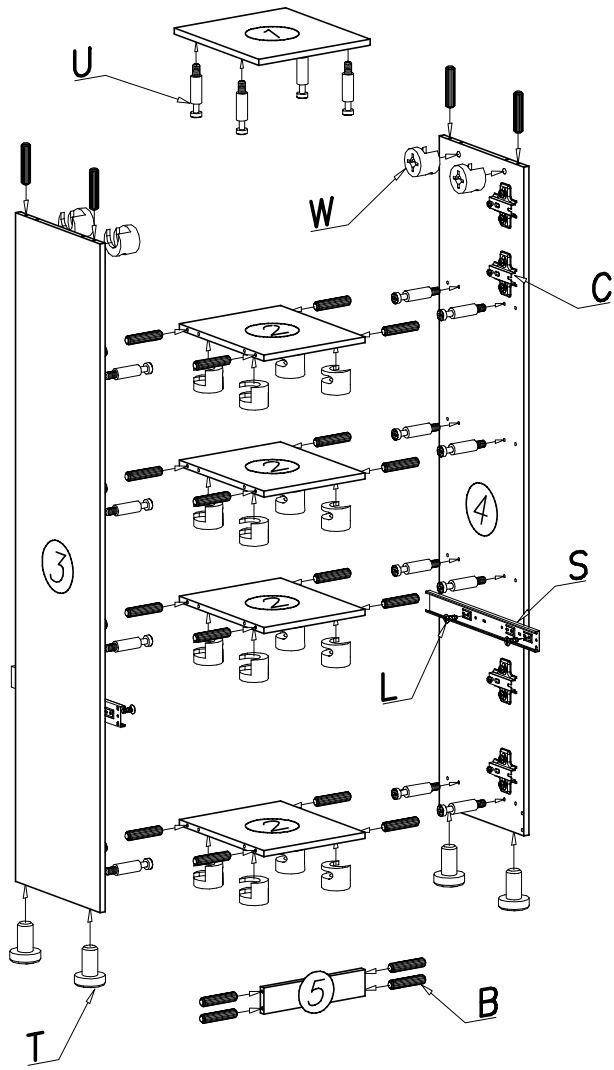

II

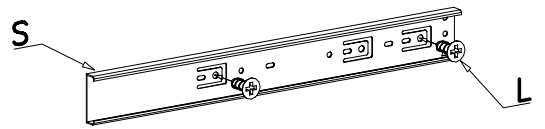
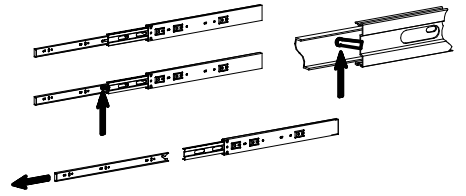
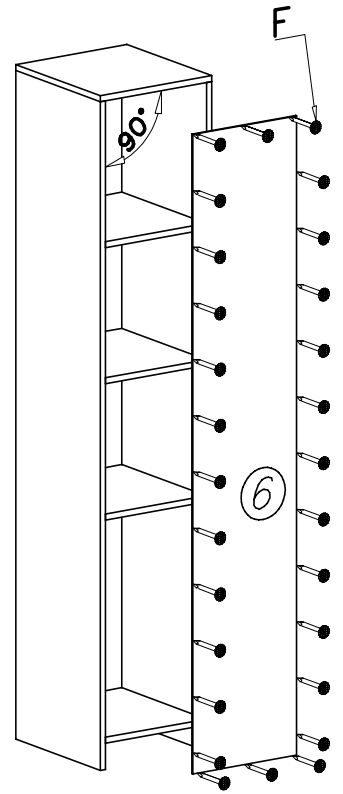

III

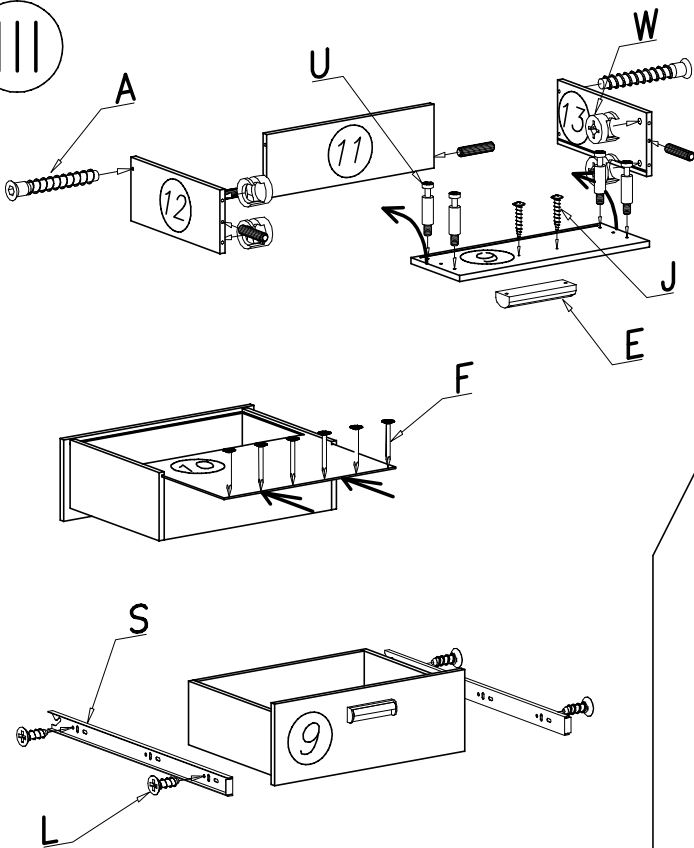

IV

