

PRZED ROZPOCZĘCIEM MONTAŻU ZAPOZNAĆ SIĘ Z INSTRUKCJĄ

Narzędzia niezbędne do montażu (nie dostarczane przez producenta)

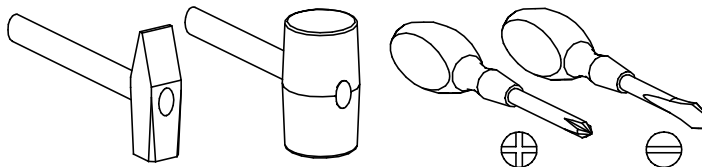

CARMELO

02

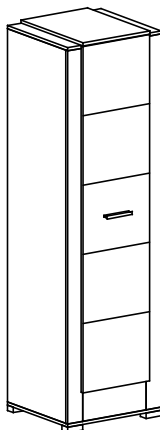

Nr	Nazwa elementu	Dł [mm]	Szer [mm]	Gr [mm]	Ilość	Kod	Paczka
1	wieniec	527	497	16	1		
2	blat dolny	560	516	16	1		
3	blat górny	560	516	16	1		
4	półka	527	497	16	2		
5	nakładka blatu górnego	534	400	16	1		
6	bok lewy	1900	500	16	1		
7	bok prawy	1900	500	16	1		
8	listwa lewa	1900	90	16	1		
9	listwa prawa	1900	90	16	1		
10	HDF ściana tylna	1920	273	2,5	2		
11	drzwi	1763	400	16	1		
12	poprzeczka dolna	380	153	16	1		

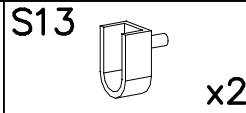
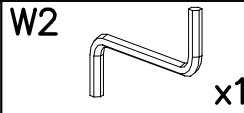
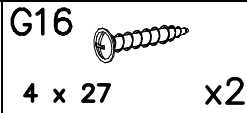
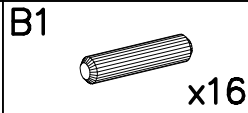
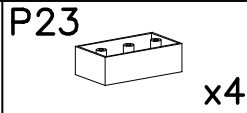
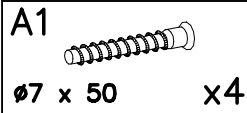
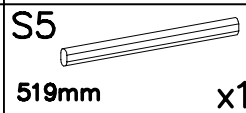
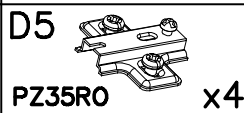
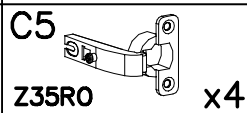
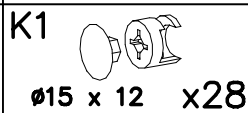
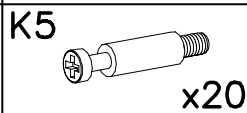
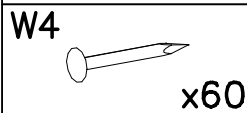
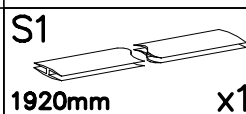
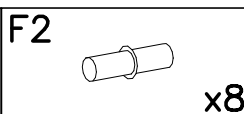
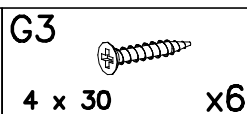
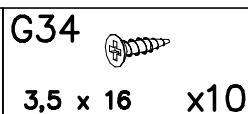
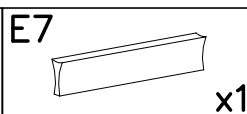
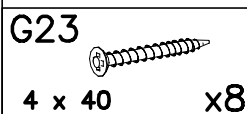
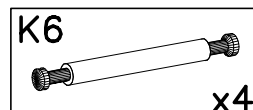
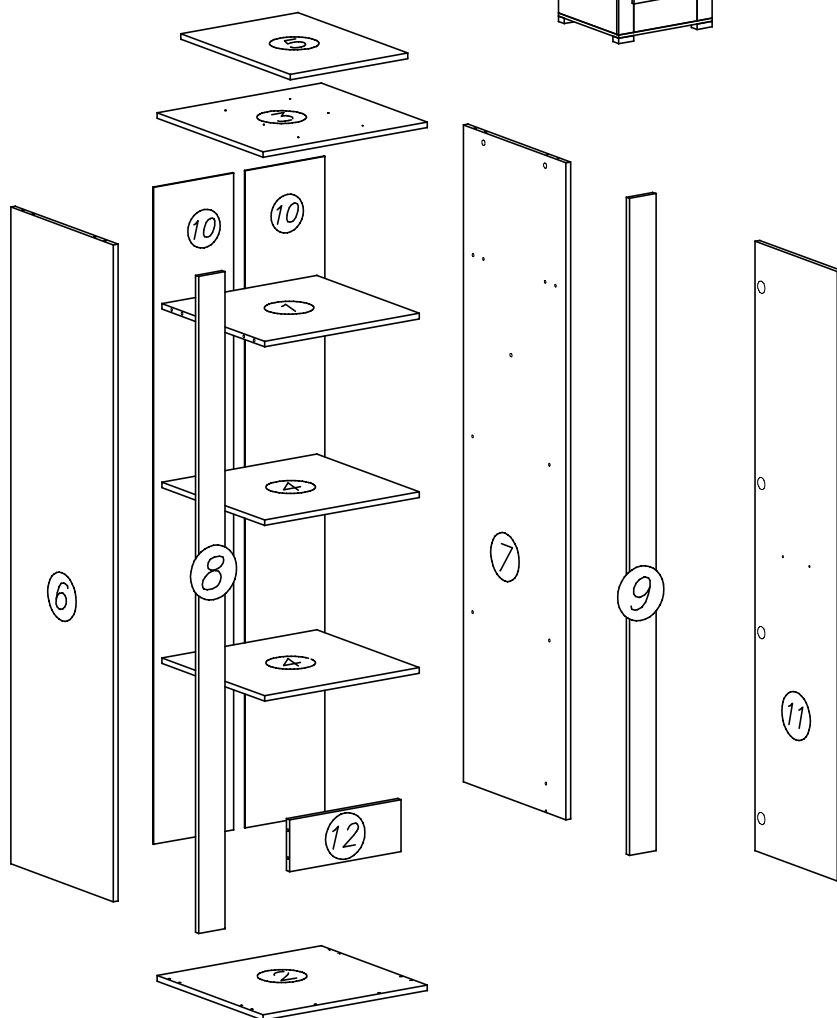

I

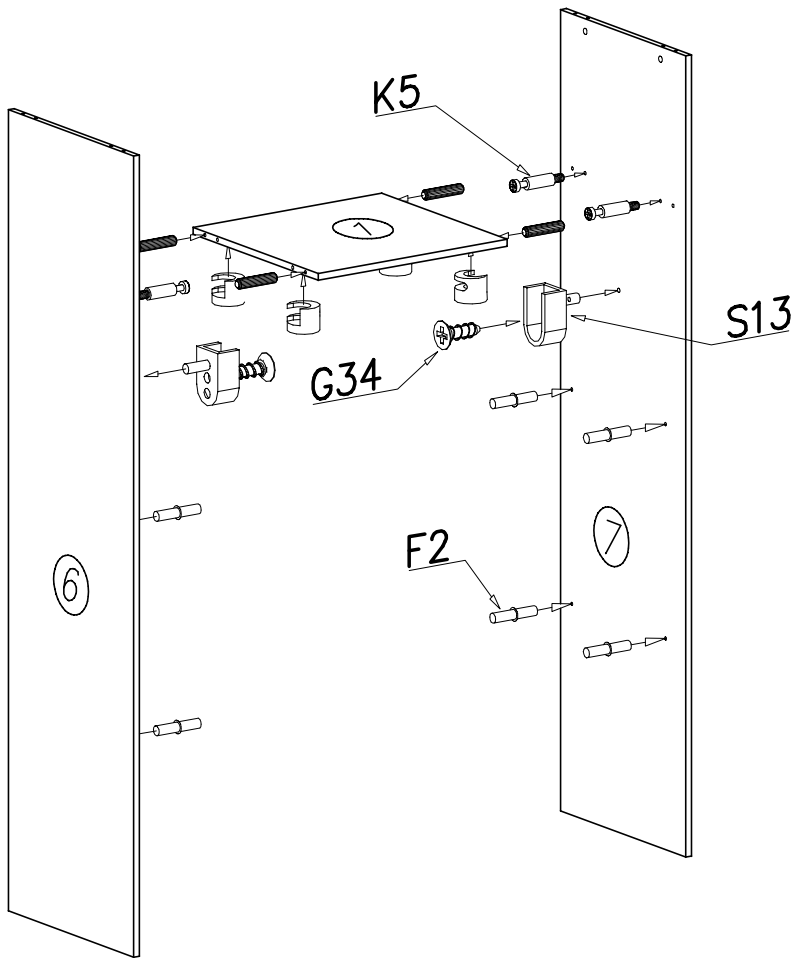

II

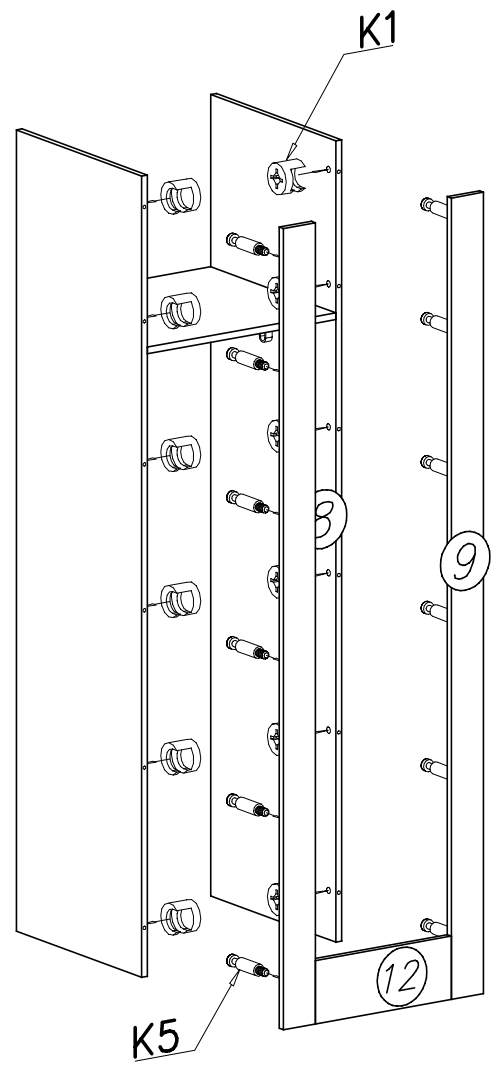

III

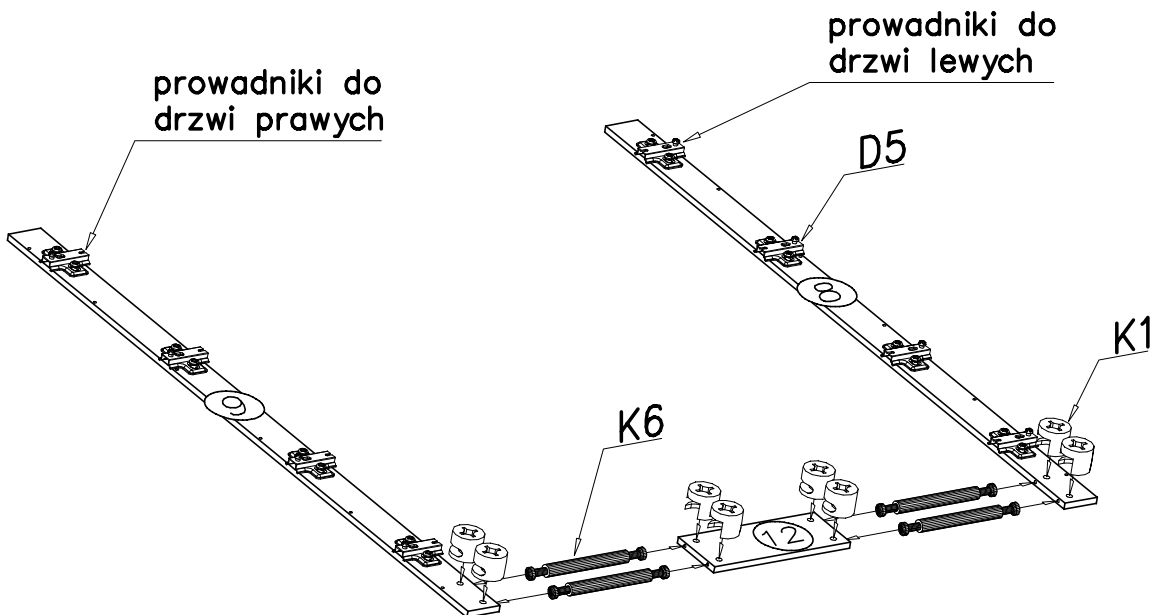

IV

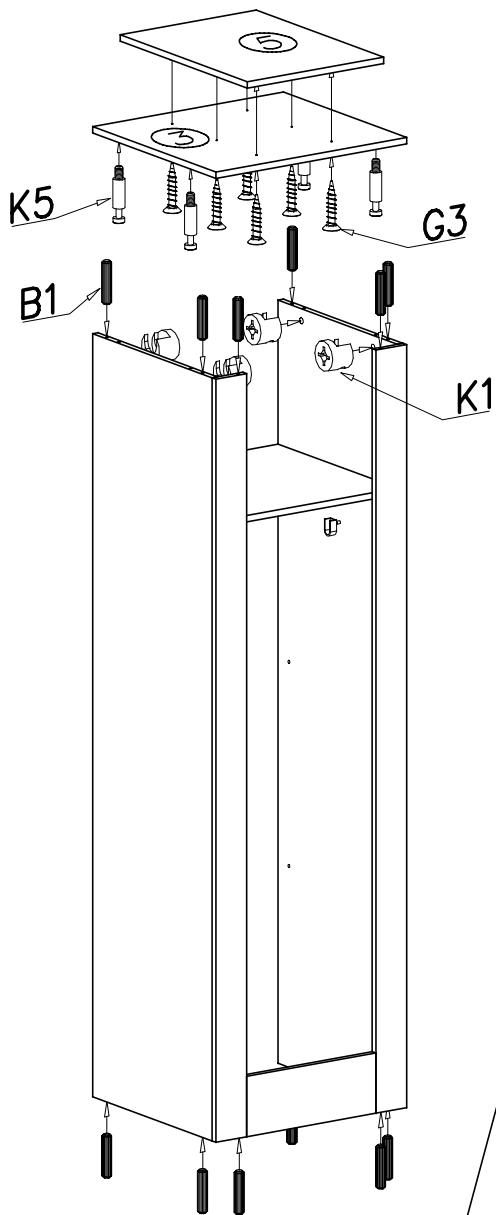

V

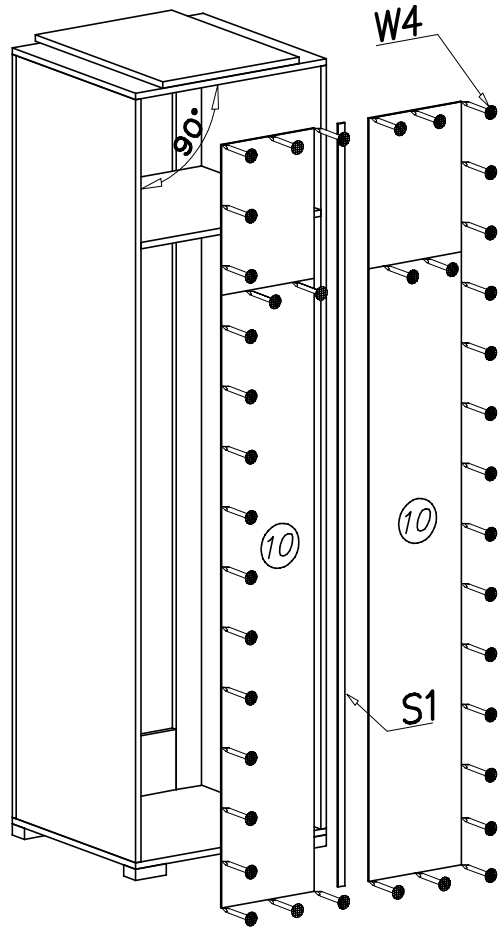

VI

Opcja: drzwi lewe

Opcja: drzwi prawe

