

PRZED ROZPOCZĘCIEM MONTAŻU ZAPOZNAĆ SIĘ Z INSTRUKCJĄ

Narzędzia niezbędne do montażu (nie dostarczane przez producenta)

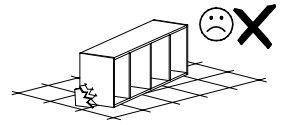
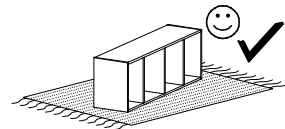
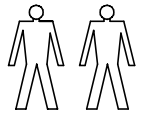
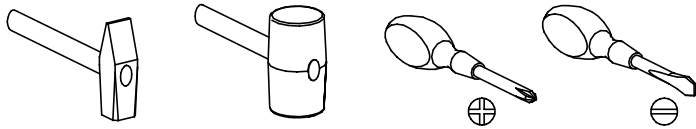

MONTOWAĆ NA MIEKKIM PODŁOŻU TYPU: KOC, DYWAN.

VERTO

V-16

Regał

WER. III

Nr	Nazwa elementu	Dł [mm]	Szer [mm]	Gr [mm]	Ilość
1	blat górny	320	370	25	1
2	blat dolny	320	370	25	1
3	HDF ściana tylna	1799	308	2,5	1
4	bok	1769	350	16	2
5	wieniec	287	347	16	4

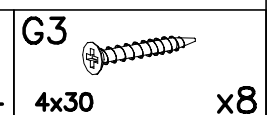
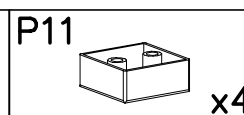
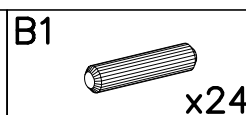
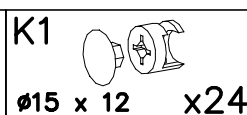
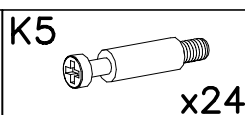
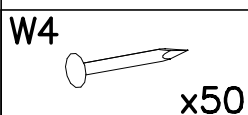
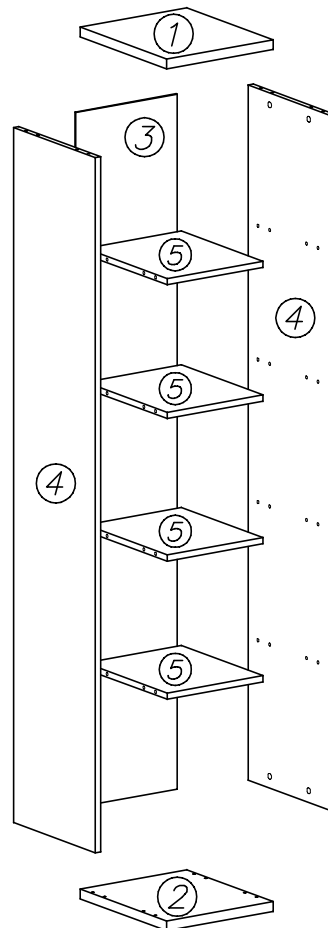
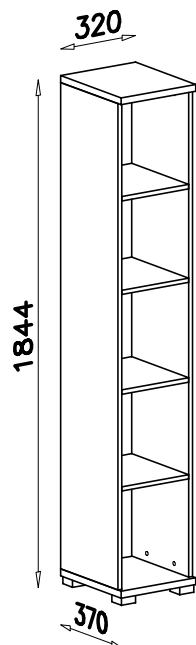

I

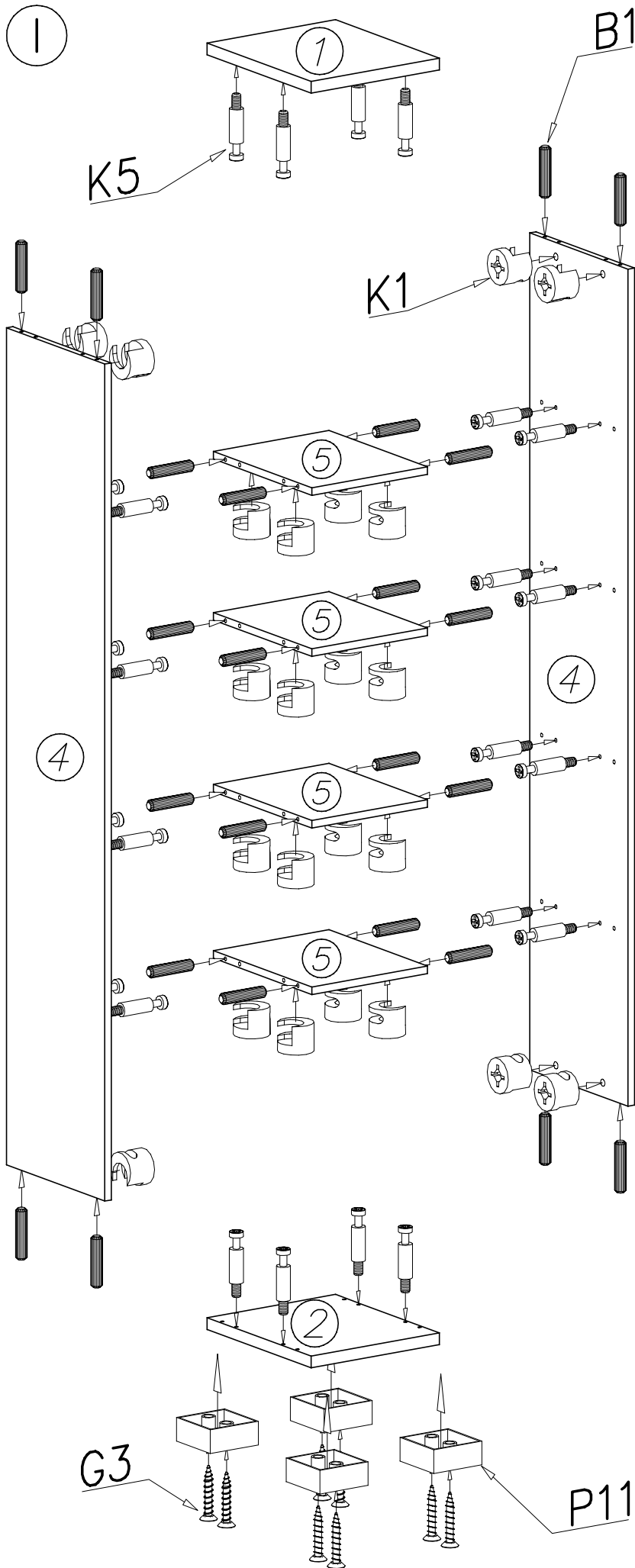

II

