

PRZED ROZPOCZĘCIEM MONTAŻU ZAPOZNAĆ SIĘ Z INSTRUKCJĄ

Narzędzia niezbędne do montażu (nie dostarczane przez producenta)

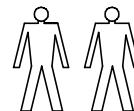
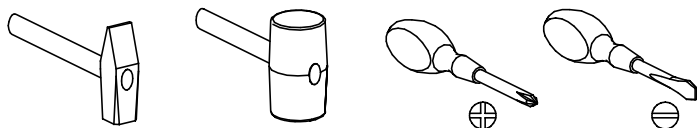

MONTOWAĆ NA MIEKKIM PODŁOŻU TYPU: KOC, DYWAN.

# VERTO

## V-15

Regał z drzwiami

WER. III

Nr	Nazwa elementu	Dł [mm]	Szer [mm]	Gr [mm]	Ilość
1	blat górny	320	370	25	1
2	blat dolny	320	370	25	1
3	HDF ściana tylna	1799	308	2,5	1
4	bok	1769	350	16	2
5	drzwi	315	1763	16	1
6	wieniec	287	347	16	4

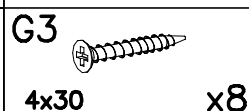
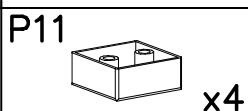
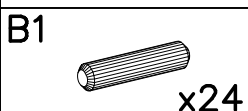
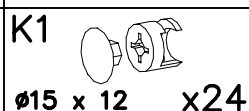
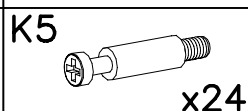
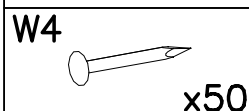
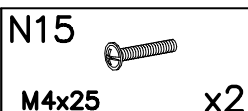
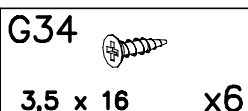
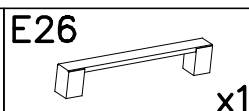
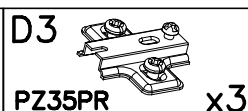
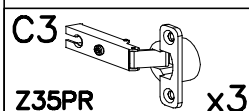
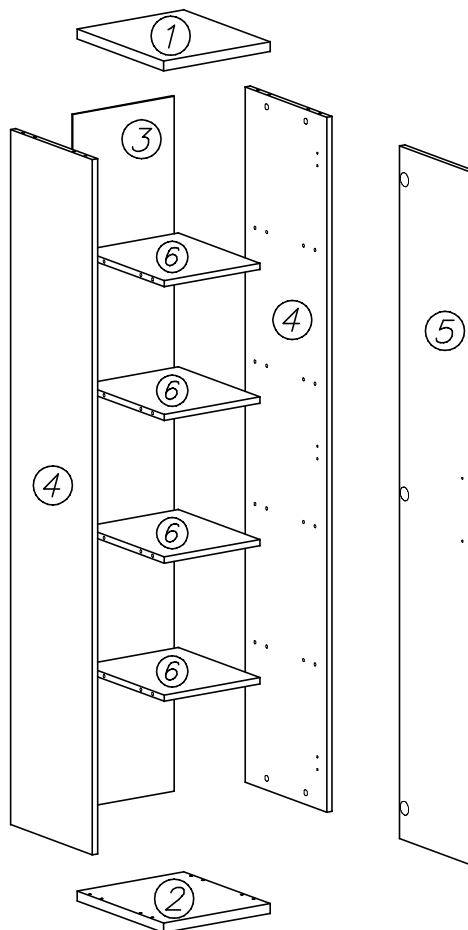
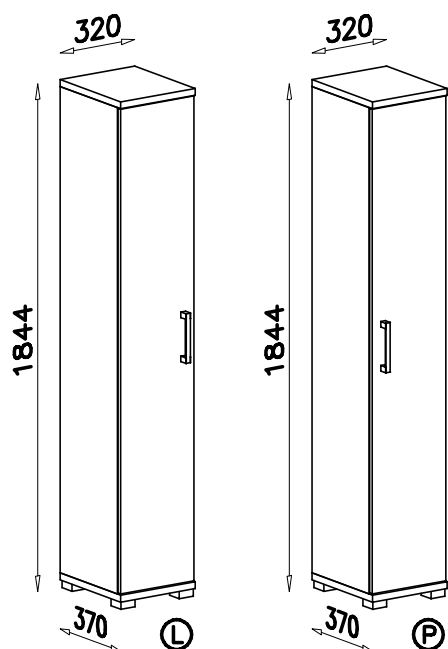

I

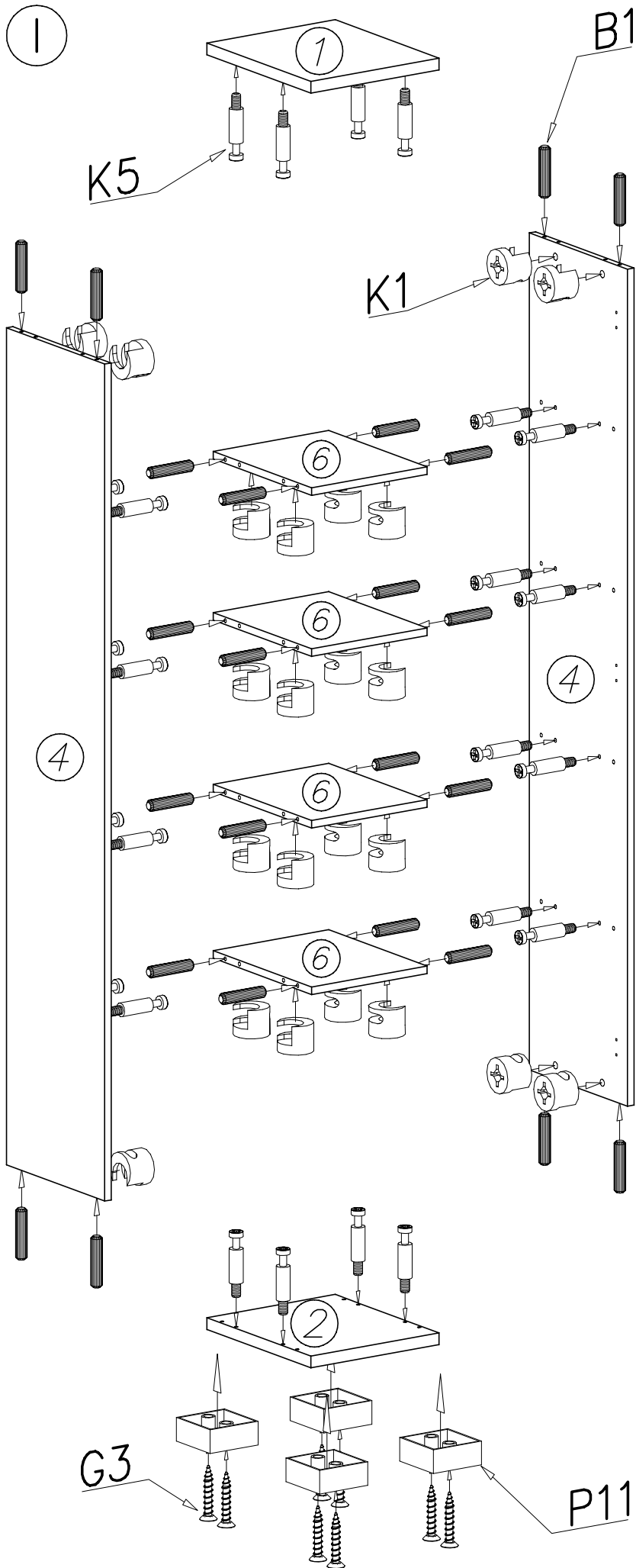

II

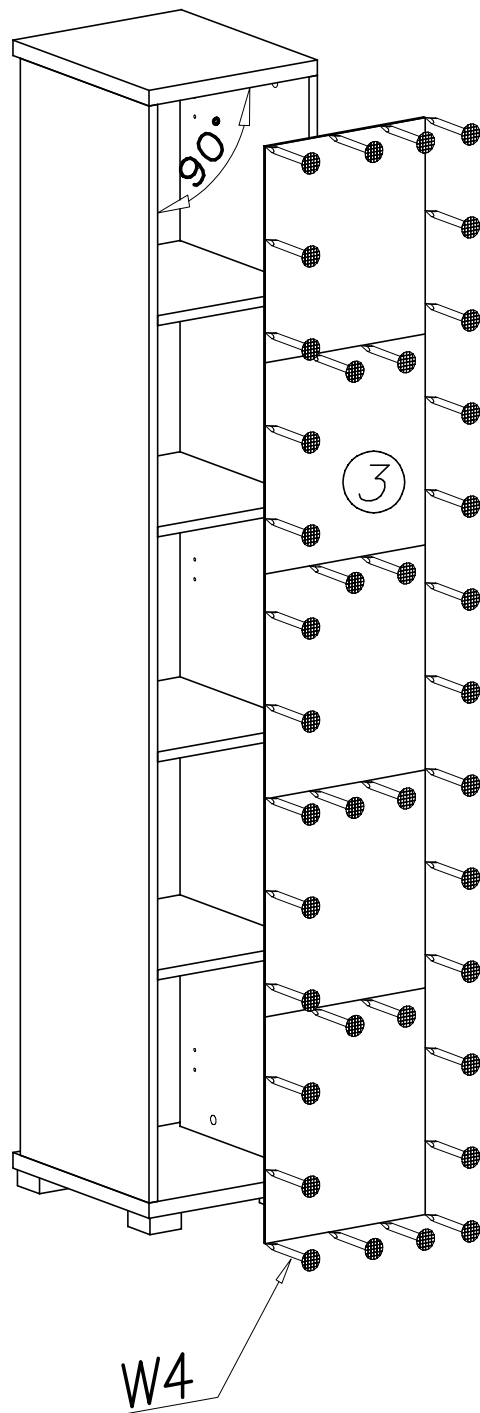

III

C3

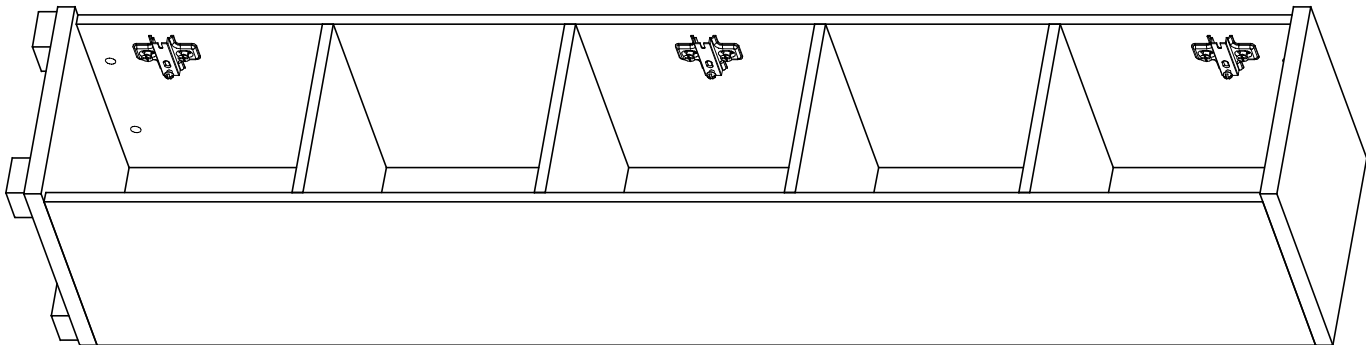
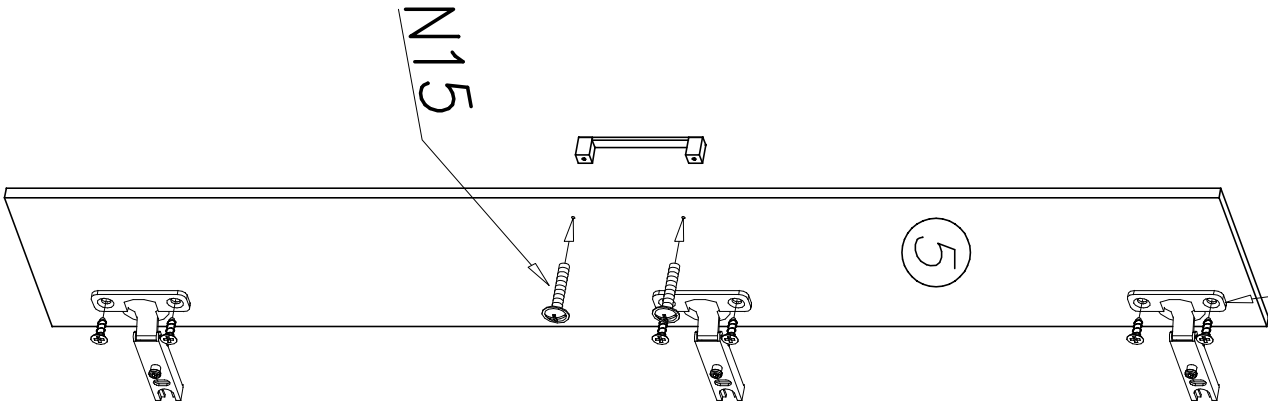

L

P

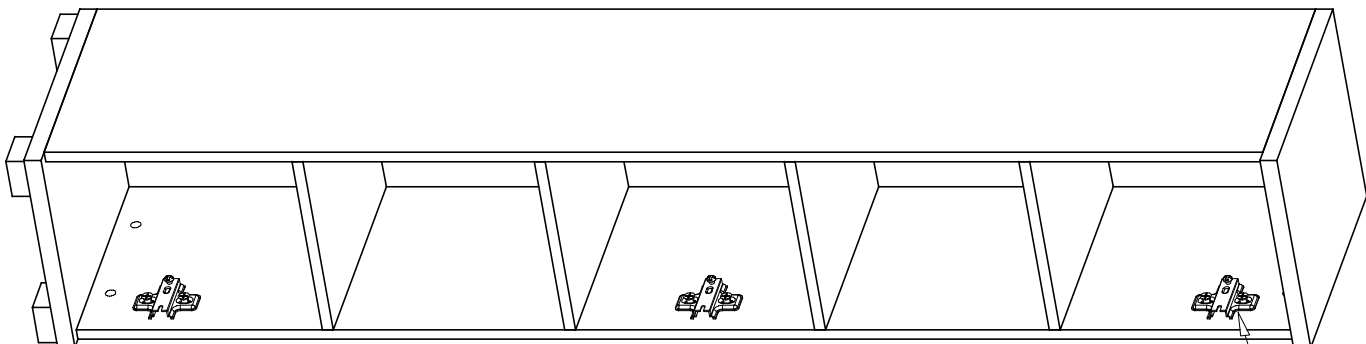

D3

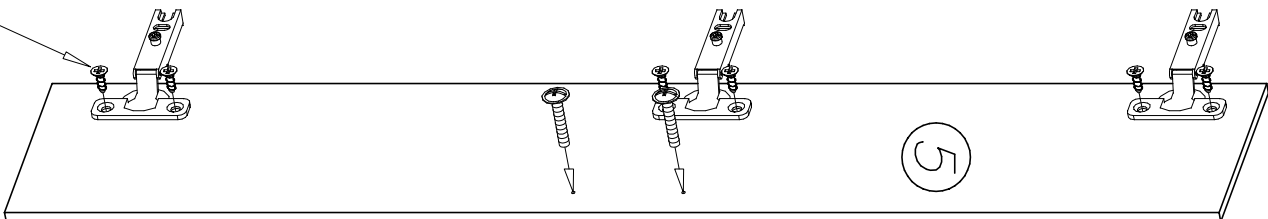

G34

E26

