

h0@

) - U

-V

#- U

h0h
-V

) - t
#- h



" t' f %o

" i X' » ¢ § ¤ ¥ j ´ a

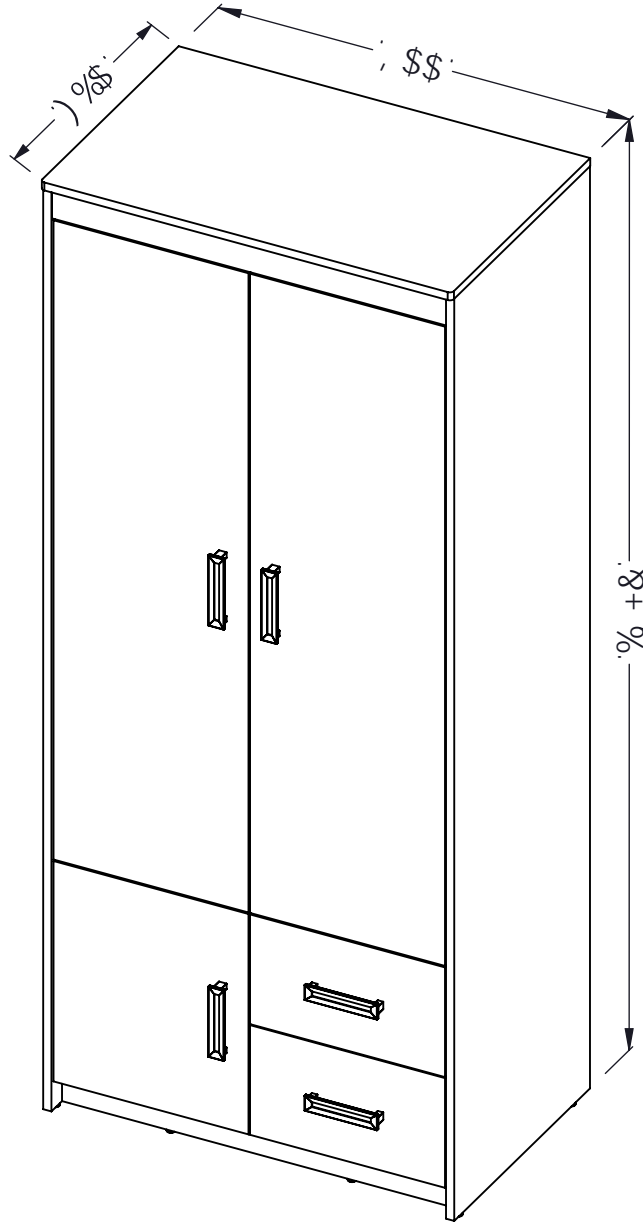



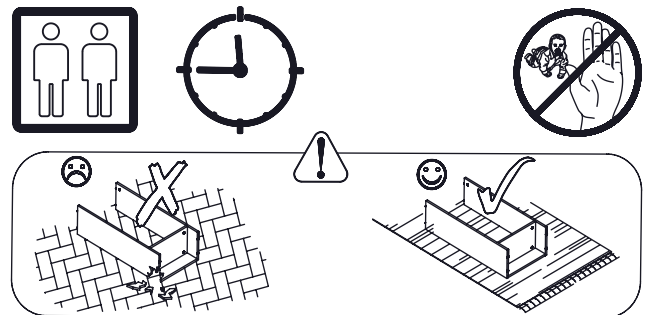
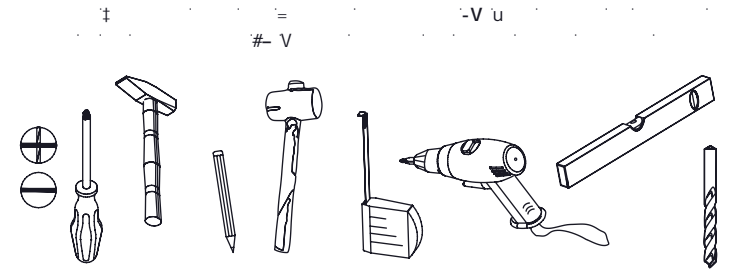



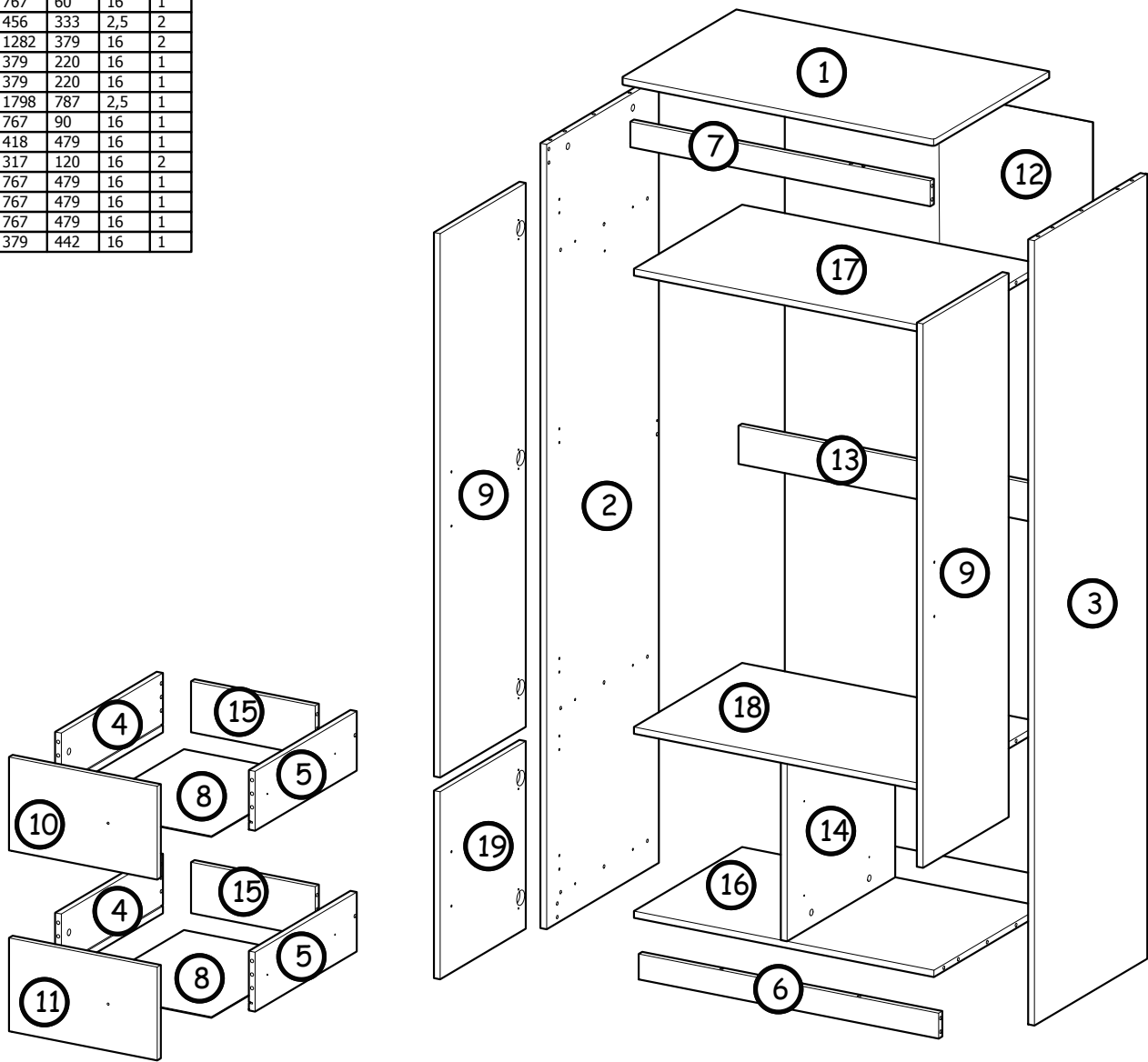

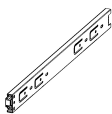





h0V

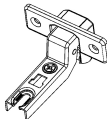

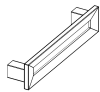
Nr	Xmm	Ymm	Zmm	Szt.
1	800	510	16	1
2	1850	500	16	1
3	1850	500	16	1
4	450	140	16	2
5	450	140	16	2
6	767	60	16	1
7	767	60	16	1
8	456	333	2,5	2
9	1282	379	16	2
10	379	220	16	1
11	379	220	16	1
12	1798	787	2,5	1
13	767	90	16	1
14	418	479	16	1
15	317	120	16	2
16	767	479	16	1
17	767	479	16	1
18	767	479	16	1
19	379	442	16	1

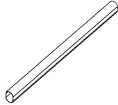

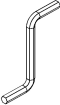
B1 60 x Ø8x35 	H10 4 x 400mm 	G20 16 x Ø5x13 	W4 89 x 	K5 28 x 34mm 	K1 28 x Ø15x12 
I20 26 x Ø4/Ø17 	A1 4 x Ø7x50 	P5 6 x 	D4 8 x 	C4 8 x 	G34 18 x 3,5x16 
E40 5 x 128mm 	N15 10 x M4x25 	S5 1 x 758mm 	S8 2 x 	G6 6 x 3x13 	W2 1 x 4mm 

I

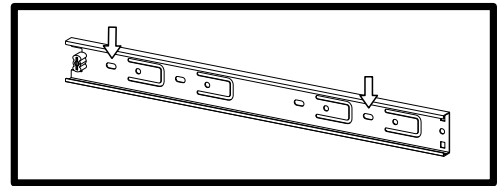
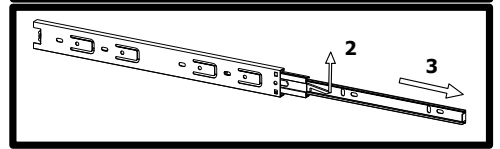
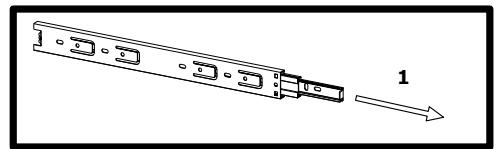
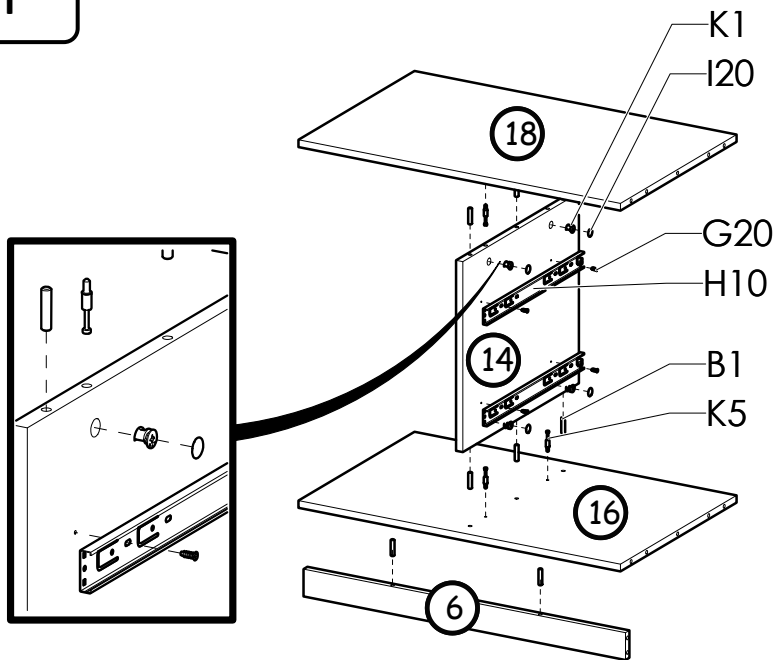

II

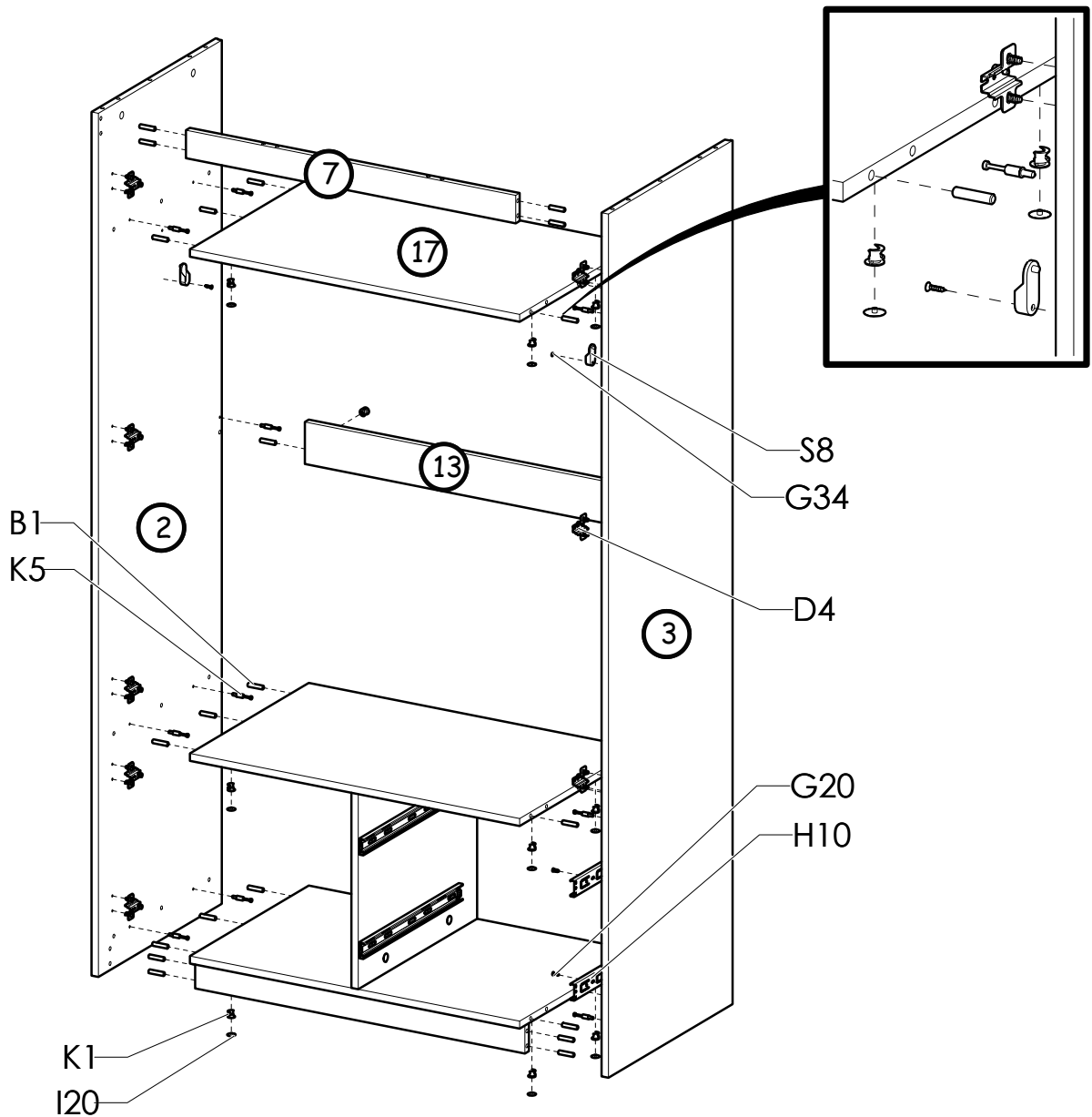

III

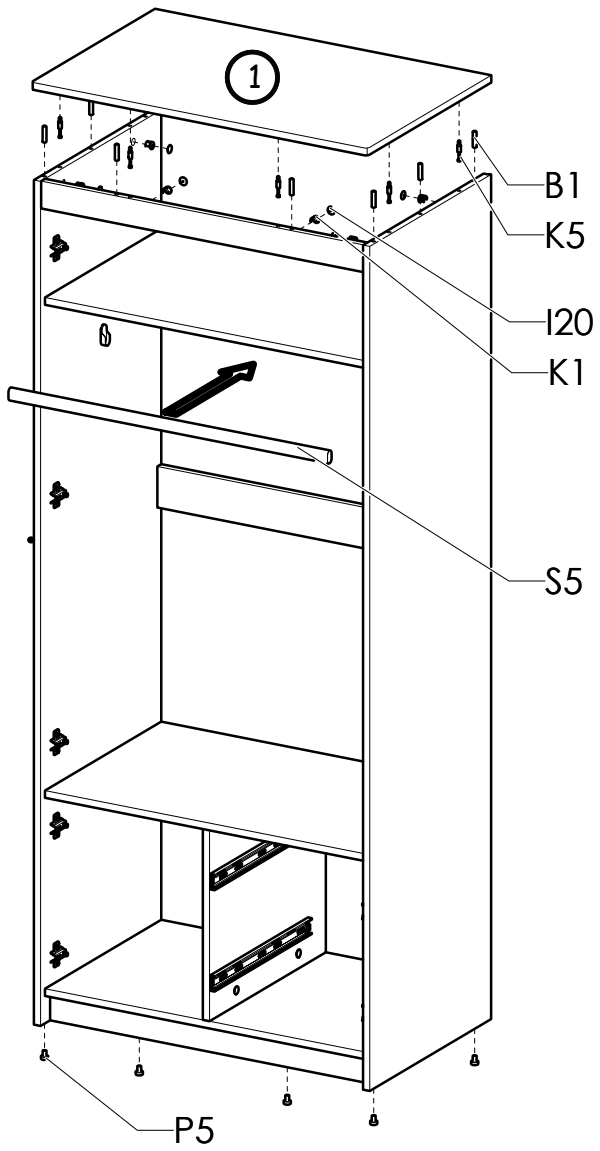

IV

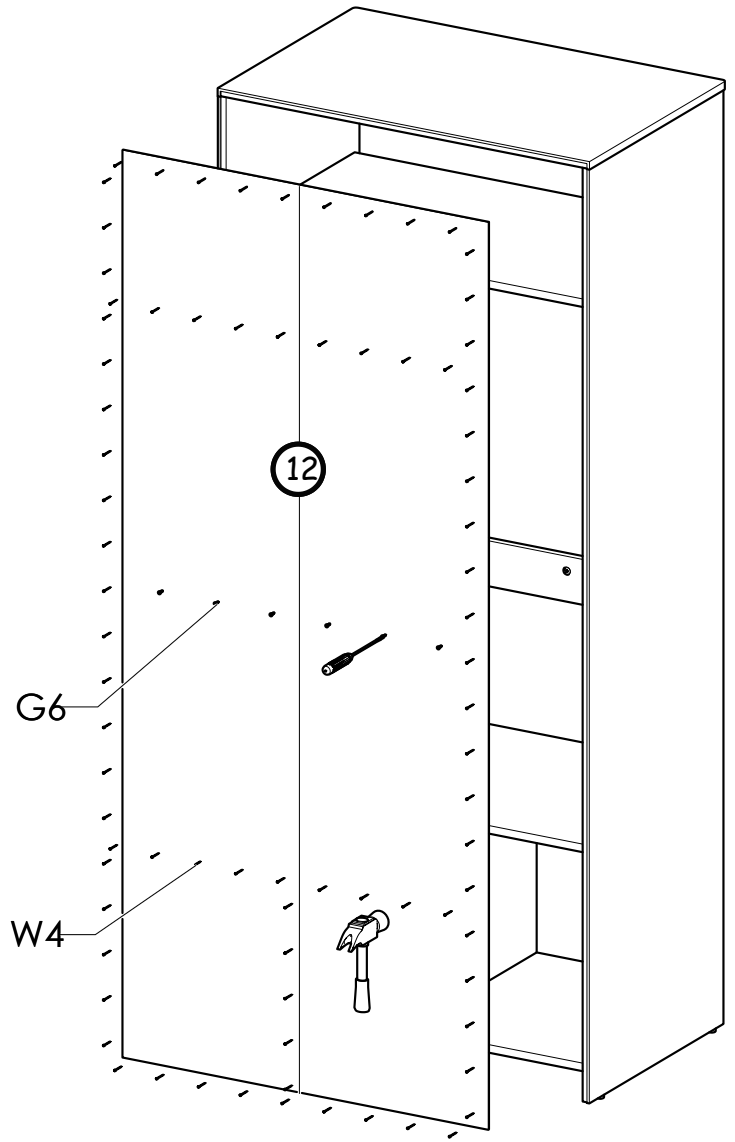

V

