

PRZED ROZPOCZĘCIEM MONTAŻU ZAPOZNAĆ SIĘ Z INSTRUKCJĄ

Narzędzia niezbędne do montażu (nie dostarczane przez producenta)

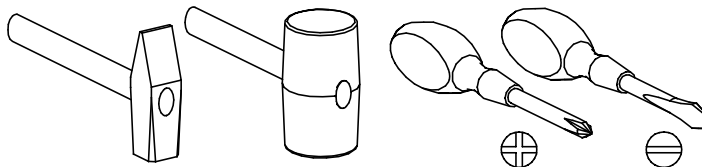

# GUMI

## G-12

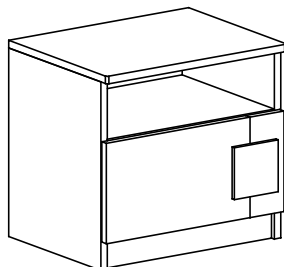

Nr	Nazwa elementu	Dł [mm]	Szer [mm]	Gr [mm]	Ilość	Kod	Paczka
1	bok lewy	400	330	16	1		
2	bok prawy	400	330	16	1		
3	blat górny	450	351	16	1		
4	wieniec	417	327	16	1		
5	cokół	417	60	16	1		
6	HDF ściana tylna	347	438	2,5	1		
7	front szuflady	445	213	16	1		
8	tył szuflady	359	140	16	1		
9	bok lewy szuflady	300	160	16	1		
10	bok prawy szuflady	300	160	16	1		
11	dno szuflady	306	376	2,5	1		

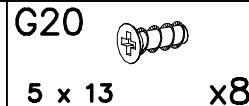
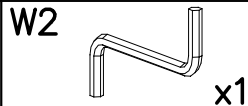
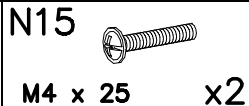
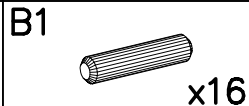
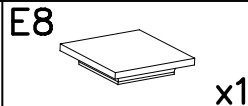
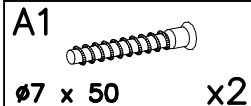
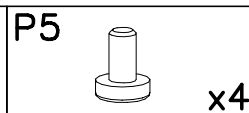
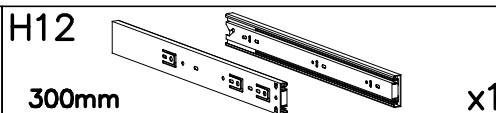
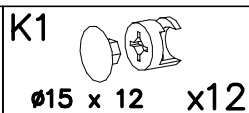
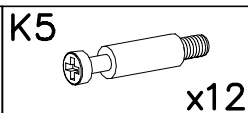
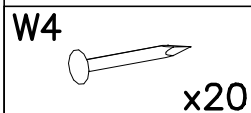
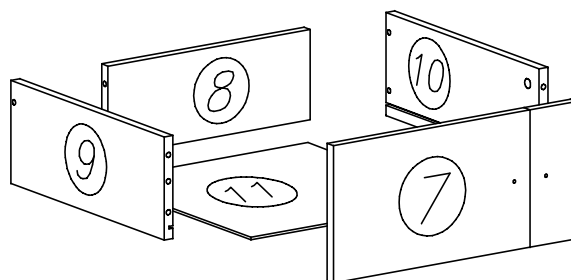
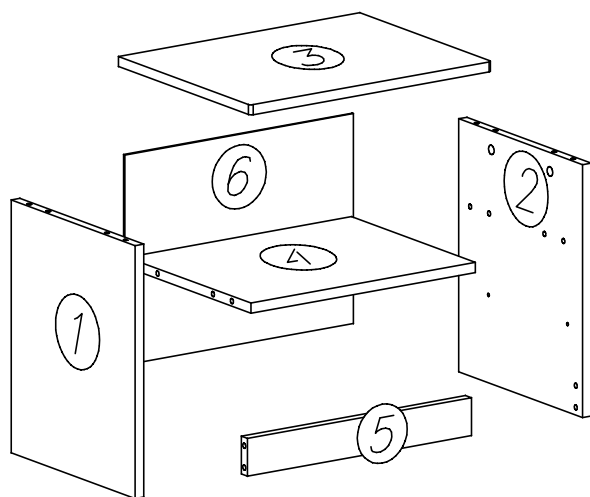

1

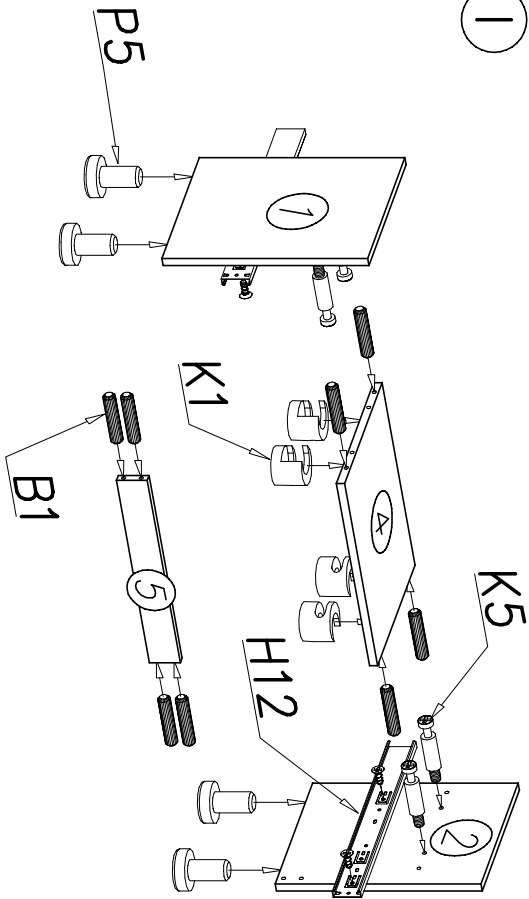

II

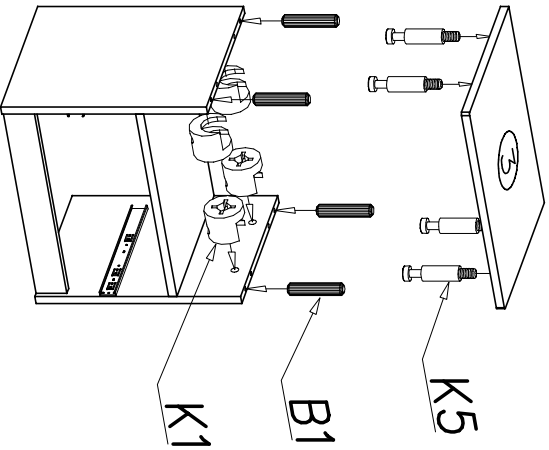

III

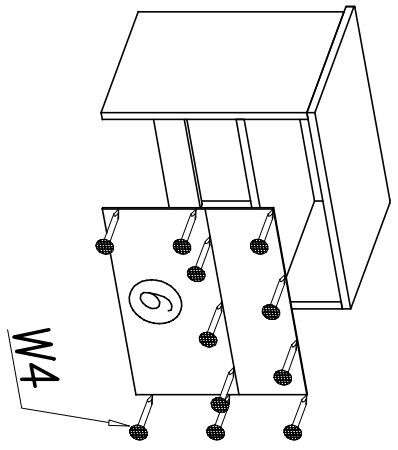

IV

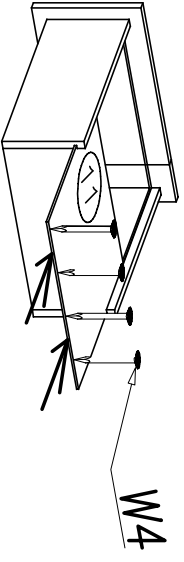
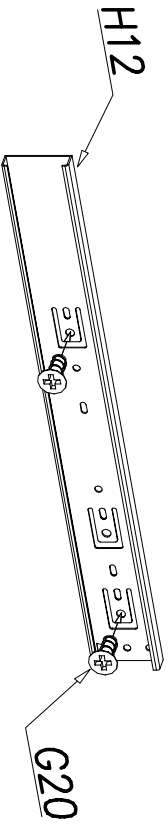
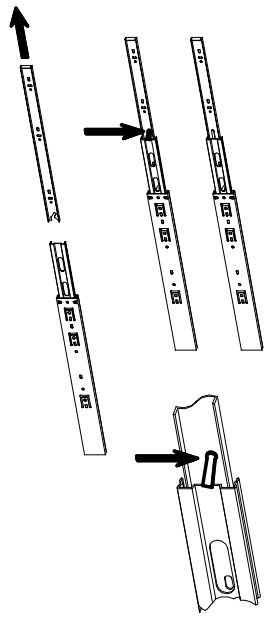

IV

