

PRZED ROZPOCZĘCIEM MONTAŻU ZAPOZNAĆ SIĘ Z INSTRUKCJĄ

Narzędzia niezbędne do montażu (nie dostarczane przez producenta)

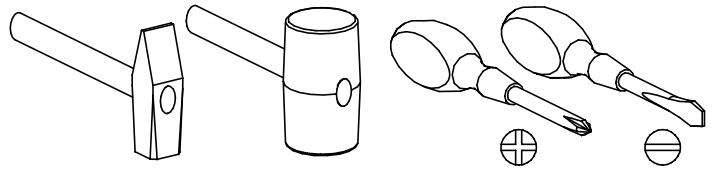

# LORENTO 08

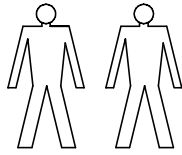
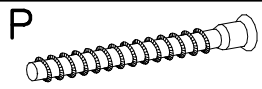
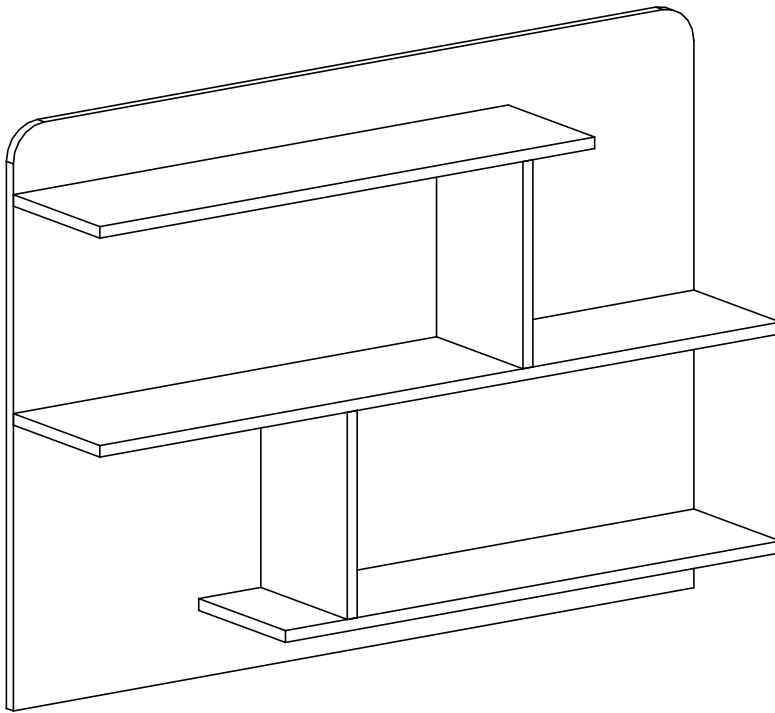

7 x 70 x2

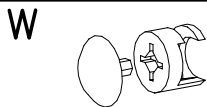

x4

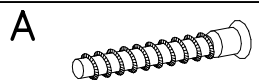

7 x 50 x12

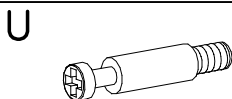

x4

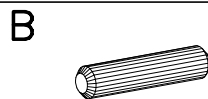

x20

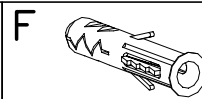

x2

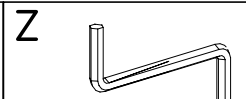

x1

I

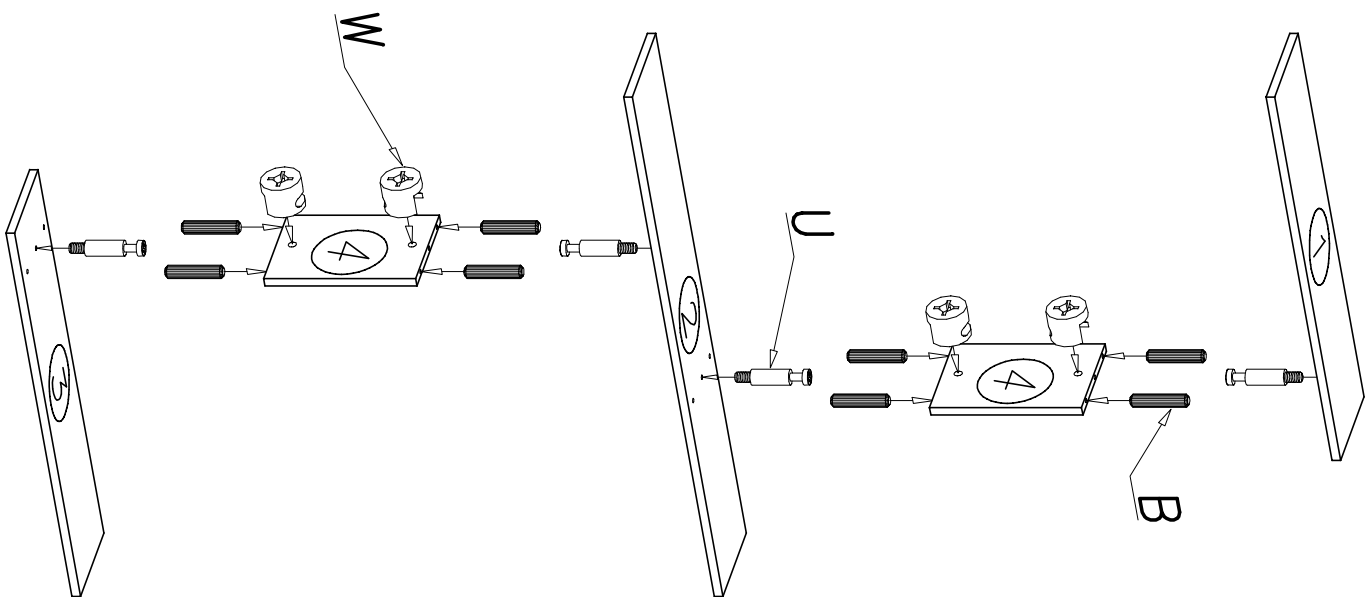

II

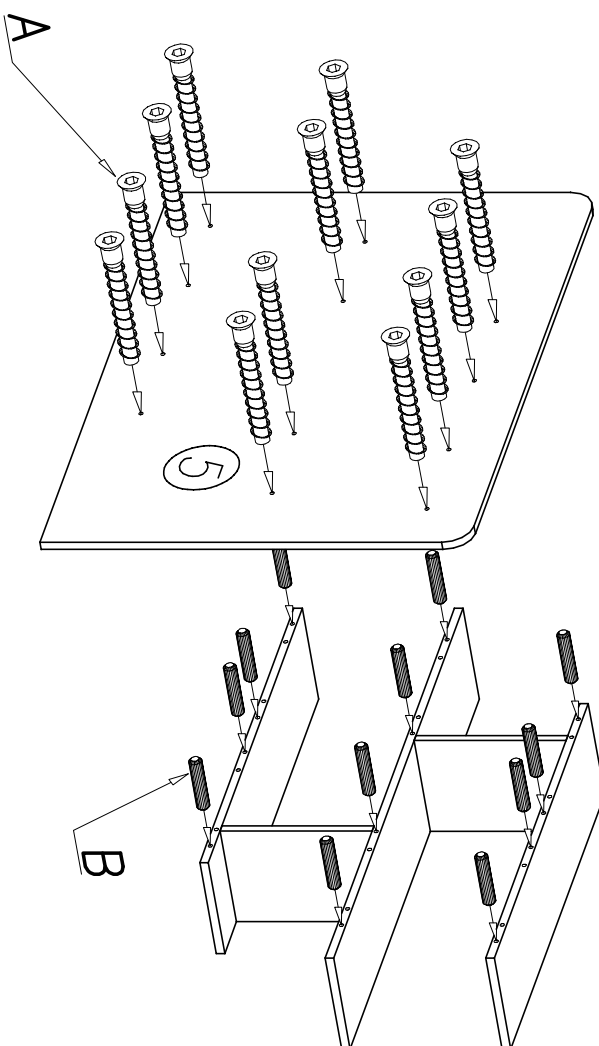

III

