

PRZED ROZPOCZĘCIEM MONTAŻU ZAPOZNAĆ SIĘ Z INSTRUKCJĄ

Narzędzia niezbędne do montażu (nie dostarczane przez producenta)

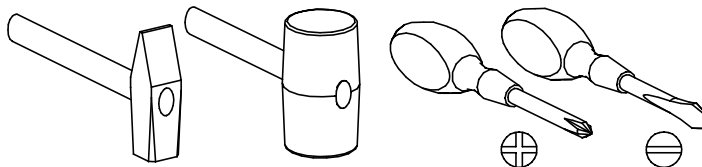

ROMERO

14L

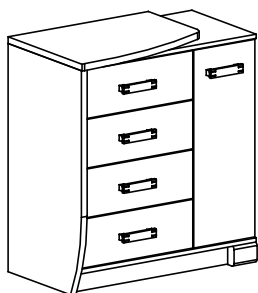

Nr	Nazwa elementu	Dł [mm]	Szer [mm]	Gr [mm]	Ilość	Kod	Paczka
1	blat górny	600	460	25	1		
2	przegroda pionowa	735	378	16	1		
3	bok prawy	735	381	16	1		
4	wieniec dolny	774	400	16	1		
5	cokół przedni	774	74	25	1		
6	cokół boczny	344	74	25	1		
7	bok lewy	841	455	25	1		
8	półka	245	378	16	1		
9	drzwi	729	265	16	1		
10	blat górny	774	400	16	1		
11	front szuflady	501	180	16	4		
12	HDF dno szuflady	356	454	2,5	4		
13	bok szuflady lewy	350	140	16	4		
14	bok szuflady prawy	350	140	16	4		
15	tył szuflady	438	120	16	4		
16	HDF ściana tylna	755	515	2,5	1		
17	HDF ściana tylna	755	264	2,5	1		

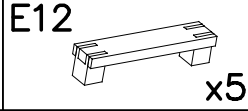
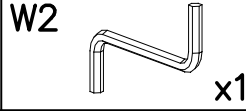
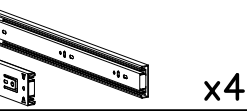
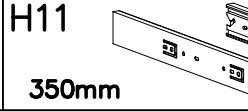
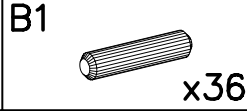
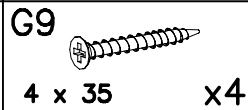
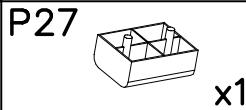
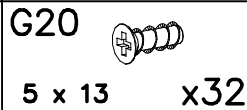
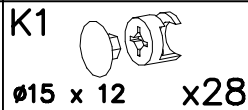
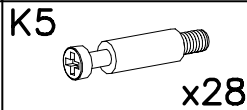
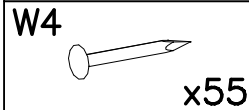
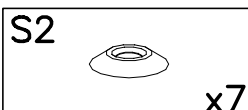
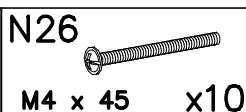
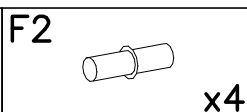
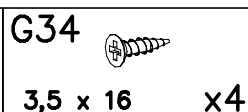
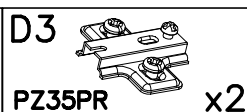
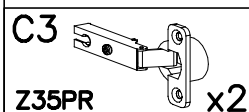
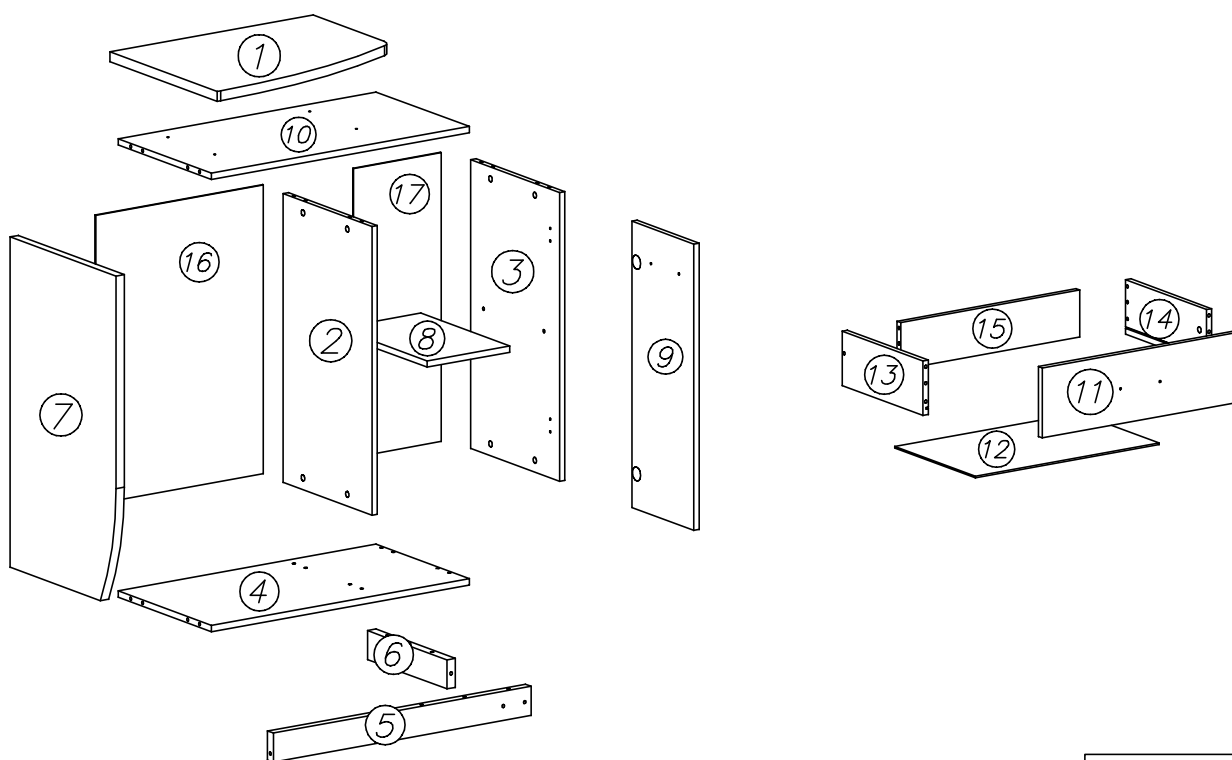

I

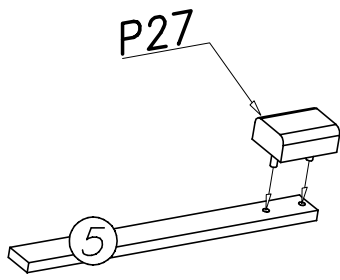

II

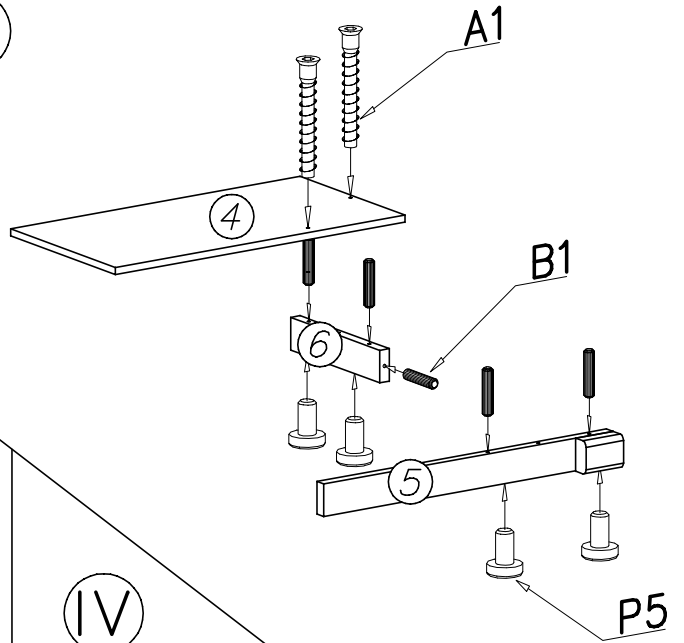

III

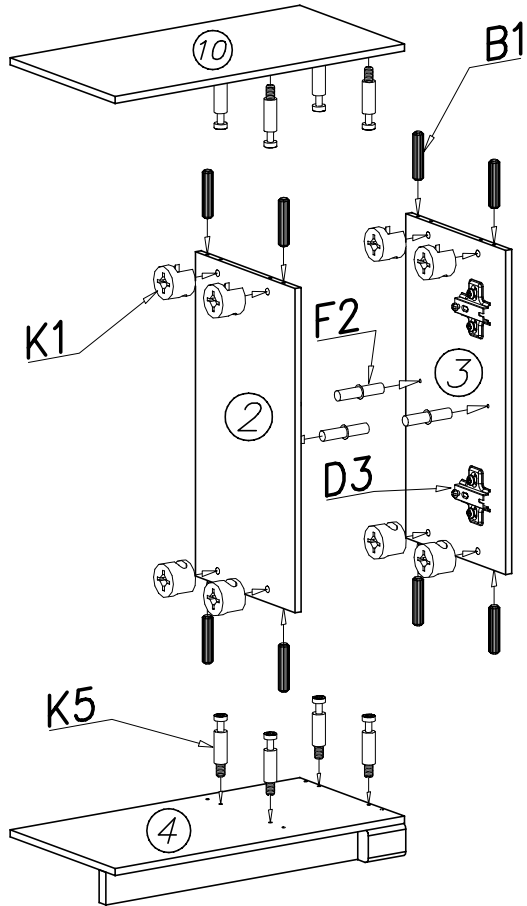

IV

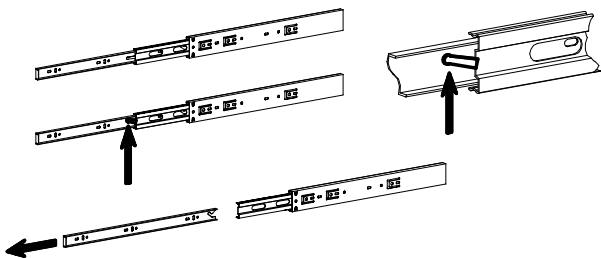
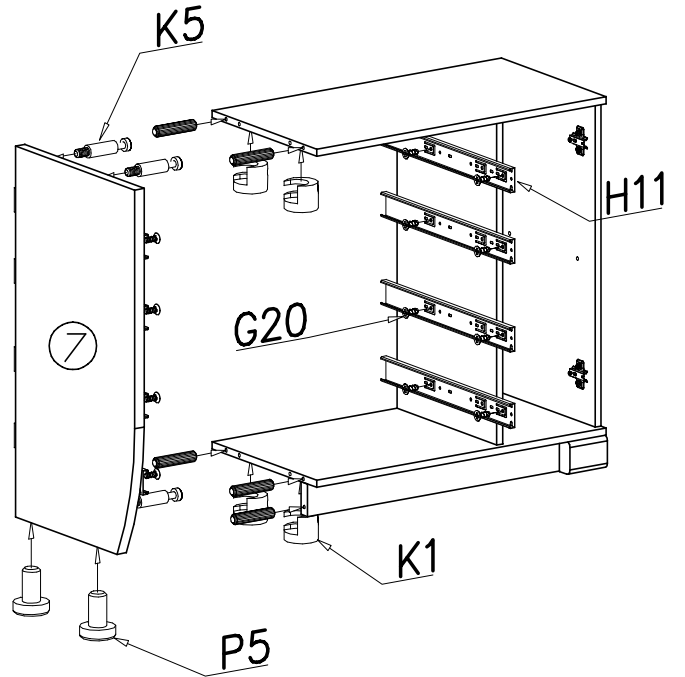

V

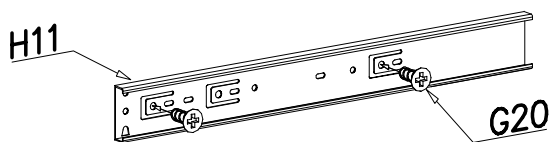
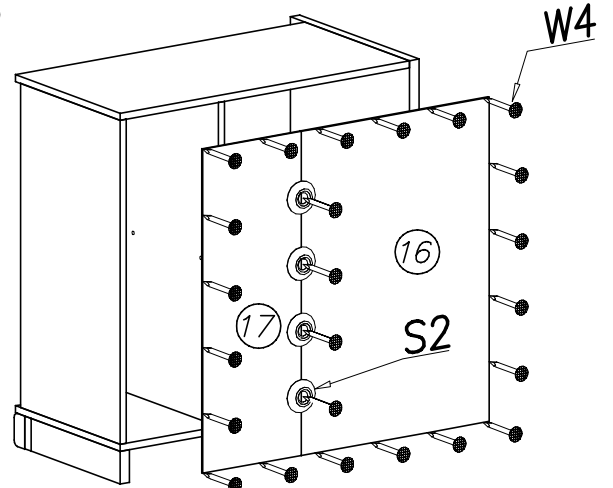

VI

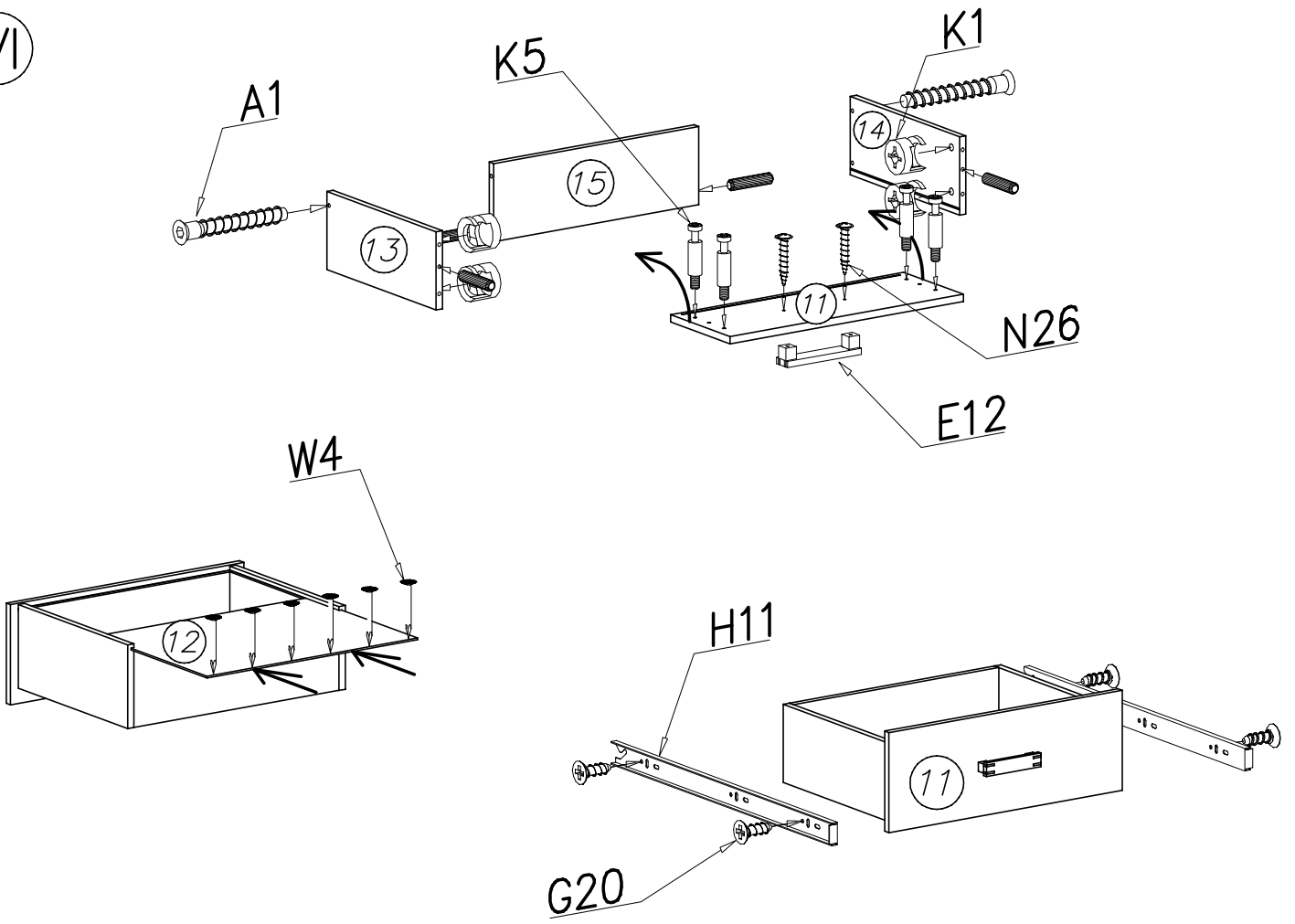

VII

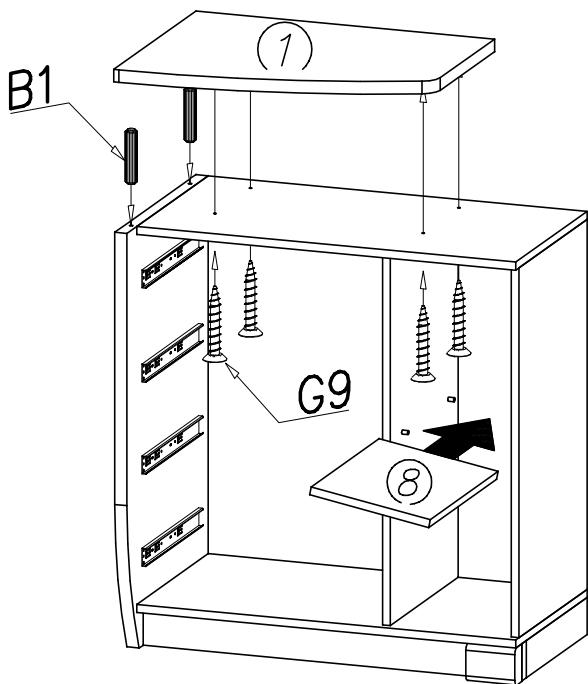

VIII

