

PRZED ROZPOCZĘCIEM MONTAŻU ZAPOZNAĆ SIĘ Z INSTRUKCJĄ

Narzędzia niezbędne do montażu (nie dostarczane przez producenta)

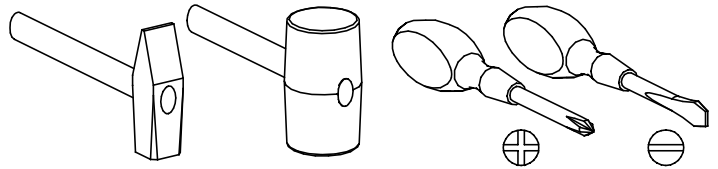
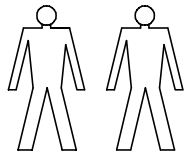

ROMERO

10

Nr	Nazwa elementu	Dł [mm]	Szer [mm]	Gr [mm]	Ilość	Kod	Paczka
1	blat	1200	250	16	2		
2	ściana tylna	1167	217	16	1		
3	bok	217	250	16	2		
4	tył	600	150	25	2		
5	przegroda	217	233	16	4		

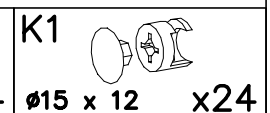
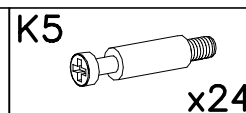
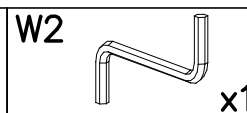
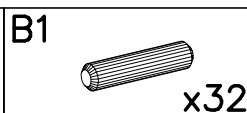
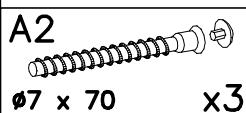
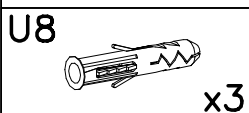
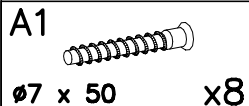
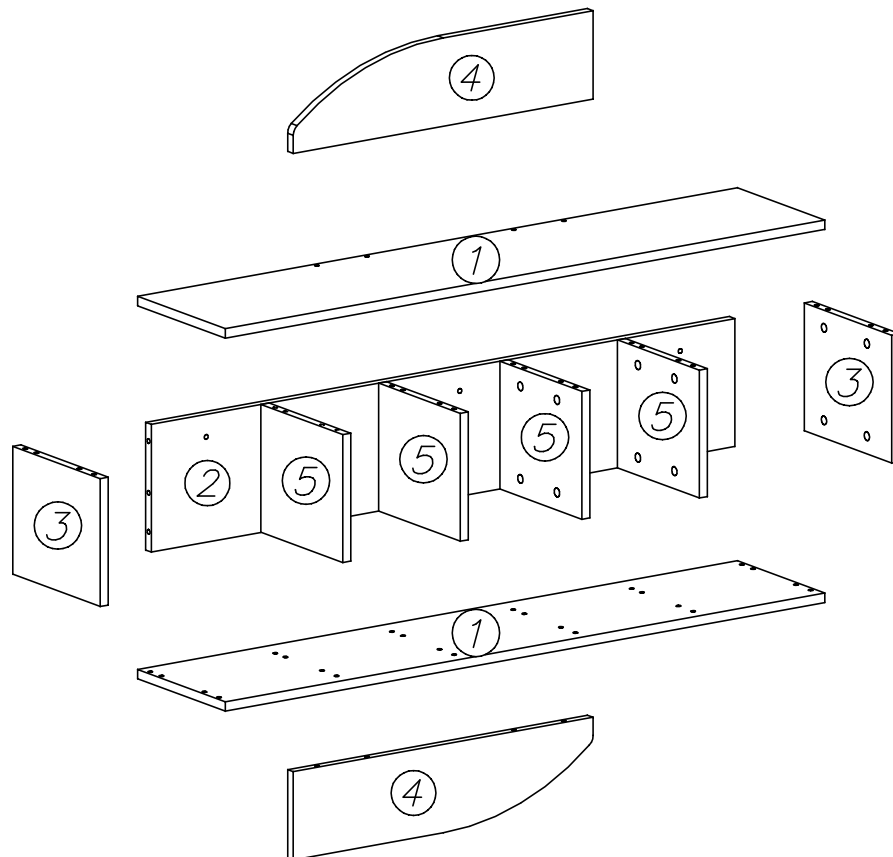
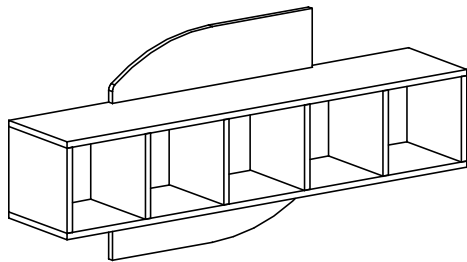

1

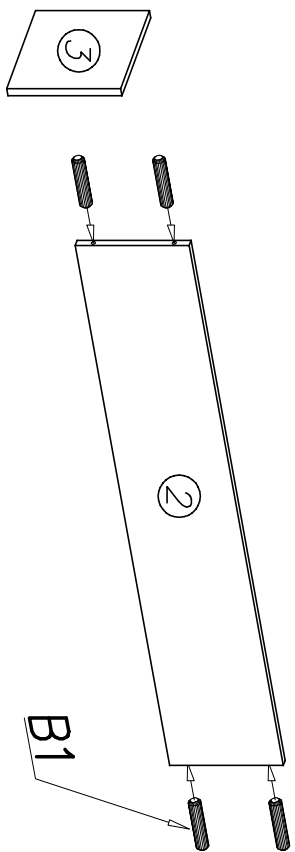

II

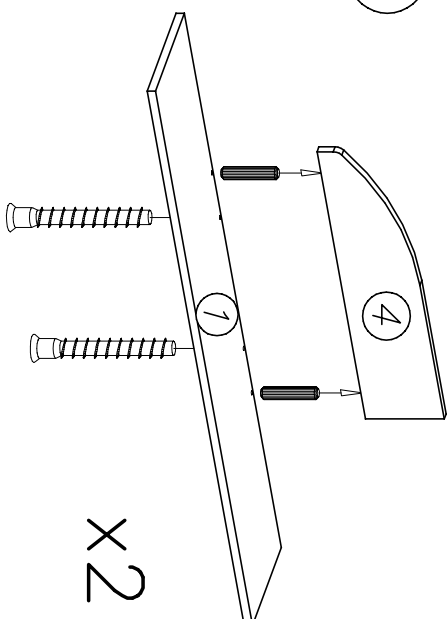

III

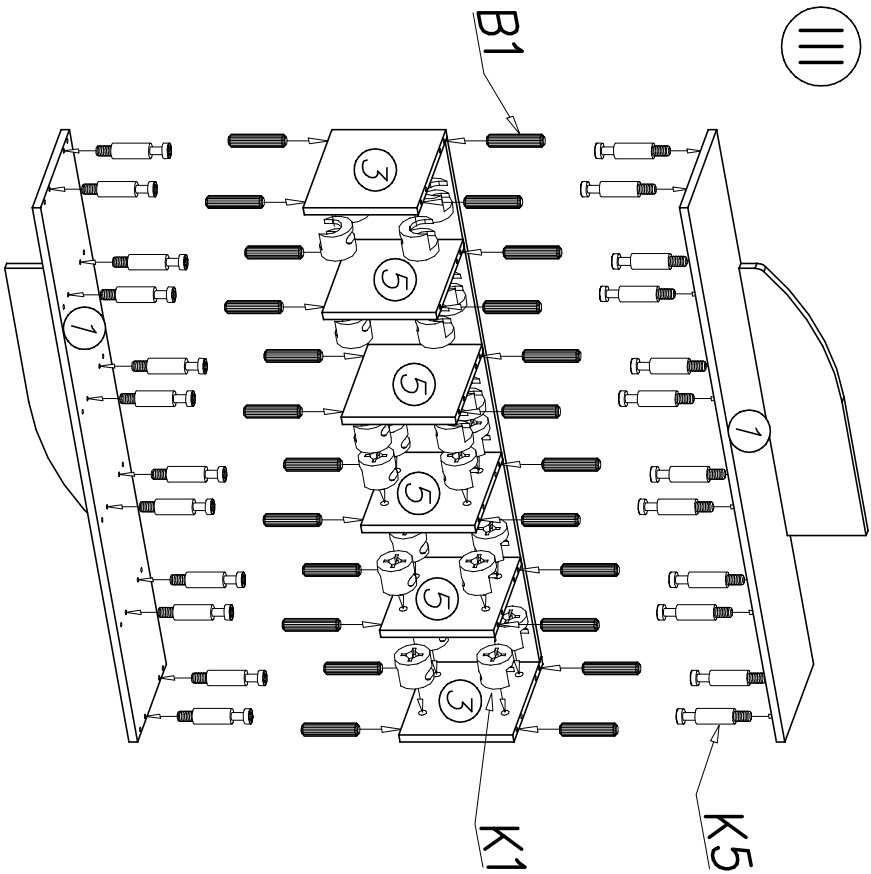

IV

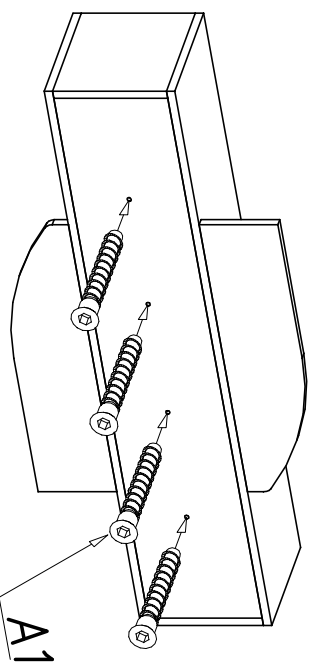

V

